



PDF700S SERIES 700 WATT AC-DC BRICK POWER SUPPLY WITH PFC

Features

- Universal Input Range 90~264Vac
- Efficiency up to 91.5%
- Full Brick Size
- Class I
- Approval Safety IEC/EN/UL 62368-1
- Operating Altitude 5000m
- Remote On/Off
- Over Temperature Protection
- Over Voltage Protection
- Continuous Short Circuit Protection
- Baseplate Cooling
- Compliance to CE101/CE102/RE101 of MIL-STD-461



MODEL NUMBER	OUTPUT VOLTAGE	OUTPUT CURRENT	RIPPLE & NOISE NOTE1 & 2	VOLTAGE ACCURACY NOTE3	LINE REGULATION NOTE4	LOAD REGULATION NOTE5	%EFF. (Typ.) NOTE6
PDF700S120	12 V	58.4 A	120 mV	±1.0%	±0.5%	±0.5%	87.5%
PDF700S240	24 V	29.2 A	240 mV	±1.0%	±0.5%	±0.5%	90%
PDF700S280	28 V	25.0 A	280 mV	±1.0%	±0.5%	±0.5%	90.5%
PDF700S480	48 V	14.6 A	480 mV	±1.0%	±0.5%	±0.5%	91%
PDF700S560	56 V	12.5 A	560 mV	±1.0%	±0.5%	±0.5%	91.5%

Note:

1. External components are required. please refer to the application note.
2. Add a 0.1uF ceramic capacitor and a 10uF E.L. capacitor to output for ripple & noise measuring @20MHz BW.
3. Voltage accuracy is set at 60% load.
4. Line regulation is measured from 100V_{ac} to 264V_{ac} with full load.
5. Load regulation is measured from 60%±40% rated load.
6. Typical efficiency at 230V_{ac} and full load at 25°C.
7. When the aluminum case of brick reaches temperature 100°C the unit will be OTP. the unit need sufficient convection and heat sink.

PART NUMBER

Series	Number of Outputs	Nominal Output Voltage	Mounting Inserts
PDF700	O	XXX	-Y (Option)
PDF700	S : Single	120 : 12V 240 : 24V 280 : 28V 480 : 48V 560 : 56V	None : Clear Mounting Inserts (3.5mm DIA.) -C0 : M3x0.5 Mounting Inserts

Part Number Example:

PDF700S120:700W, Single 12V_{dc} Output, Clear Mounting Inserts



TECHNICAL SPECIFICATIONS

(All specifications are typical at nominal input, full load at 25°C unless otherwise noted.)

ABSOLUTE MAXIMUM RATINGS

PARAMETER	NOTES and CONDITIONS	Device	Min.	Typ.	Max.	Units
Input Voltage		All	90		264	V _{ac}
Operating Case Temperature	At the center of base plate	All	-40		100	°C
Storage Temperature		All	-55		105	°C
Operating Altitude		All			5000	m

INPUT CHARACTERISTICS

PARAMETER	NOTES and CONDITIONS	Device	Min.	Typ.	Max.	Units
Operating Voltage Range		All	100		240	V _{ac}
Input Frequency Range		All	47		63	Hz
Maximum Input Current	100% Load, V _{in} =100Vac	All			9	A
Leakage Current	Only PDF700S Brick	All			0.01	mA
Inrush Current	V _{in} =240V _{ac} , Cold start at 25°C (External inrush resister 10Ω)	All			35	A
Under Voltage Protection		All	63	70	77	V _{ac}
Power Factor	230V _{ac} /50Hz @ Full load	All		0.97		

OUTPUT CHARACTERISTICS

PARAMETER	NOTES and CONDITIONS	Device	Min.	Typ.	Max.	Units
Output Voltage Set Point	V _{in} =115V _{ac} and 230V _{ac} , I _o =60% I _o max., T _c =25°C	PDF700S120	11.88	12	12.12	V _{dc}
		PDF700S240	23.76	24	24.24	
		PDF700S280	27.72	28	28.28	
		PDF700S480	47.52	48	48.48	
		PDF700S560	55.44	56	56.56	
Operating Output Current Range	V _{in} =115V _{ac} and 230V _{ac} , T _c =25°C	PDF700S120	0		58.4	A
		PDF700S240	0		29.2	
		PDF700S280	0		25.0	
		PDF700S480	0		14.6	
		PDF700S560	0		12.5	
Holdup Time	V _{in} =115Vac (Refer to the application note)	All		16		mS
Output Voltage Regulation						
Load Regulation	20% Load to 100% load	All			±0.5	%
Line Regulation	V _{in} =High line to low line	All			±0.5	%
Output Voltage Trim Range	P _o ≤ max. rated power, I _o ≤ I _o max.	PDF700S560 Others	-5		+1.8 +5	%
Over Current Protection	Hiccup mode, auto recovery	All	105		195	%
Over Voltage Protection	Latch off (recycle AC input to restart)	PDF700S120		14.8	16.8	V _{dc}
		PDF700S240		30.3	33.6	
		PDF700S280		34.4	39.2	
		PDF700S480		55.9	57.6	
		PDF700S560		58.0	59.9	
Output Ripple and Noise	<ol style="list-style-type: none"> Add a 0.1uF ceramic capacitor and a 10uF aluminum electrolytic capacitor to output. Oscilloscope is 20MHz band width Ambient temperature=25°C The output capacitor is necessary, such as load capacitance in the table below 	PDF700S120		80	120	mV
		PDF700S240		160	240	
		PDF700S280		180	280	
		PDF700S480		260	480	
		PDF700S560		260	560	



PDF700S Series

PARAMETER	NOTES and CONDITIONS	Device	Min.	Typ.	Max.	Units
Load Capacitance	1. Input voltage is 115V _{ac} and 230V _{ac} 2. Output is max. load 3. Ambient temperature=25°C	PDF700S120	11700		58340	uF
		PDF700S240	8000		29170	
		PDF700S280	8000		25000	
		PDF700S480	2820		14590	
		PDF700S560	2820		12500	

EFFICIENCY

PARAMETER	NOTES and CONDITIONS	Device	Min.	Typ.	Max.	Units
Efficiency	1. Output is rated load 2. Ambient temperature=25°C @ input voltage is 230V _{ac}	PDF700S120		87.5		%
		PDF700S240		90		
		PDF700S280		90.5		
		PDF700S480		91		
		PDF700S560		91.5		

ISOLATION CHARACTERISTICS

PARAMETER	NOTES and CONDITIONS	Device	Min.	Typ.	Max.	Units
Input to Output	1 Minute (without dielectric breakdown)	All			3000	V _{ac}
Input to Earth (Ground)	1 Minute (without dielectric breakdown)	All			2000	V _{ac}
Output to Earth (Ground)	1 Minute (without dielectric breakdown)	All			500	V _{ac}
Isolation Resistance	Input to output	All	100			MΩ

FEATURE CHARACTERISTICS

PARAMETER	NOTES and CONDITIONS	Device	Min.	Typ.	Max.	Units
Switching Frequency		All		220		kHz
Over Temperature Shutdown	Temperature at the center part of base plate, auto recovery	All		110		°C
Over Temperature Recovery				105		

GENERAL SPECIFICATIONS

PARAMETER	NOTES and CONDITIONS	Device	Min.	Typ.	Max.	Units
MTBF	I _o =100%, T _a =25°C per MIL-HDBK-217F I _o =100%, T _a =25°C, Telcordia SR332	All	250 1900			k hours
Humidity	Non-condensing	All			93	% RH
Shock	Meets MIL-STD-810F Table 516.5, Table 516.5-I 10ms, each axis 3 times(±X · ±Y · ±Z axis)	All		75		g
Vibration	Meets MIL-STD-810F Table 514.5C-VIII, 15~2000Hz, X · Y · Z axis, 1hr (each axis),. total 3 hrs.	All		4		g
Weight		All		210		grams
Dimensions		All	4.60x2.40x0.50 Inches (116.8x61.0x12.7mm)			
Case Material	Plastic DAP UL 94V-0					
Base Plate Material	Aluminum baseplate					
Potting Material	UL 94V-0					
Safety	Class I, IEC/EN/UL 62368-1					
EMC Emission	EN 55032					Class A
Conducted Disturbance	EN 55032					Class A
Radiated Disturbance	EN 55032					Class A
Harmonic Current Emissions	EN 61000-3-2:2014					
Voltage Fluctuations & Flicker	EN 61000-3-3:2013					
EMC Immunity	EN 55035					
Electrostatic Discharge (ESD)	IEC 61000-4-2:2008, Air Discharge: ±8kV Contact Discharge: ±4kV					Criterion A
Radio-Frequency, Continuous Radiated Disturbance	IEC 61000-4-3:2020					Criterion A
Electrical Fast Transient (EFT)	IEC 61000-4-4:2012, ±1kV, ±2kV					Criterion A



PDF700S Series

GENERAL SPECIFICATIONS

Surge	IEC61000-4-5:2014+A1:2017 L-N: $\pm 0.5\text{kV}$, $\pm 1\text{kV}$, $\pm 2\text{kV}$, L-E(ground): $\pm 0.5\text{kV}$, $\pm 1\text{kV}$, $\pm 2\text{kV}$, $\pm 4\text{kV}$	Criterion A
Conducted Disturbances, Induced by RF Fields	IEC 61000-4-6:2013+COR1:2015	Criterion A
Power Frequency Magnetic Field	IEC 61000-4-8:2009	Criterion A
Voltage Dips	IEC 61000-4-11: 2004+A1:2017, Dip: 30% Reduction, Dip >95% Reduction	Criterion A
Voltage Interruptions	IEC 61000-4-11: 2004+A1:2017, >95% Reduction	Criterion B
MIL-STD-461 EMI (With External Circuits)	Compliance to CE101 (Submarine), CE102, RE101	
Application Note Link	PDF700S Series App Notes	

CHARACTERISTIC CURVE

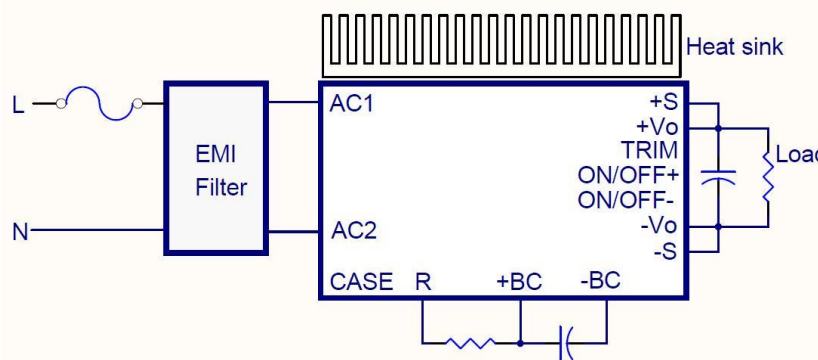

Simplified Application Circuit

Power Derating Curve

PDF700S120 Derating Curve
with Heatsink M-B012 (Vin=115V)

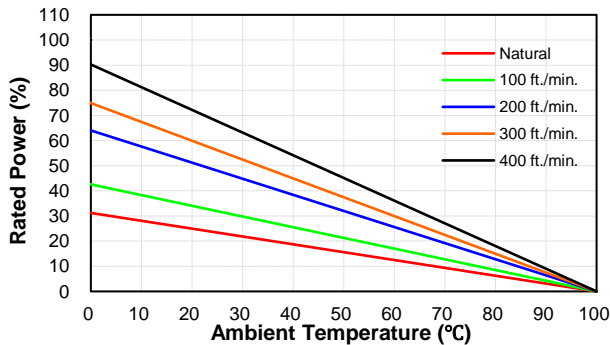

PDF700S120 Derating Curve
with Heatsink M-B012 (Vin=230V)

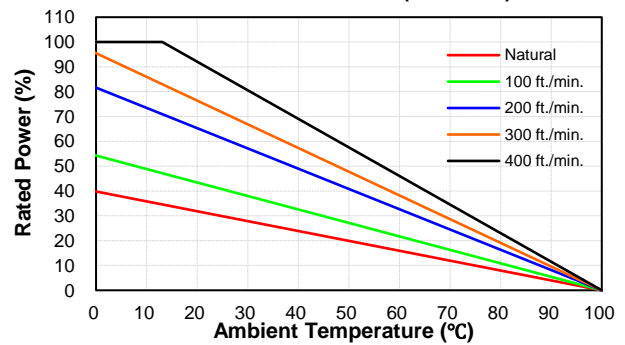

PDF700S240/280/480/560 Derating Curve
with Heatsink M-B012 (Vin=115V)

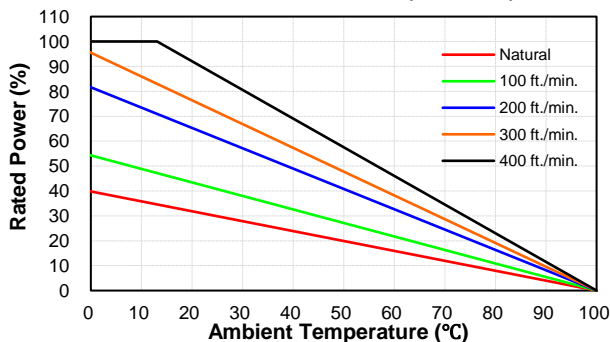

PDF700S240/280/480/560 Derating Curve
with Heatsink M-B012 (Vin=230V)

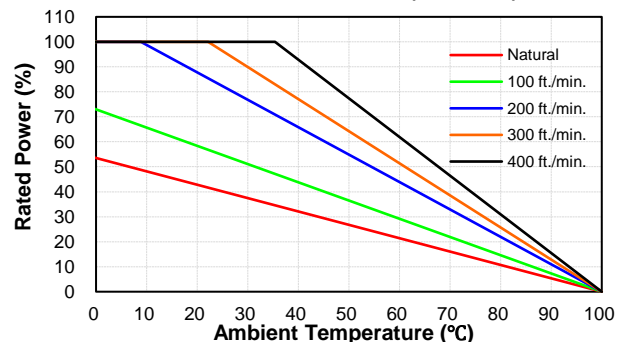



PDF700S Series

PDF700S120/240/280/480/560
Input Voltage Derating Curve

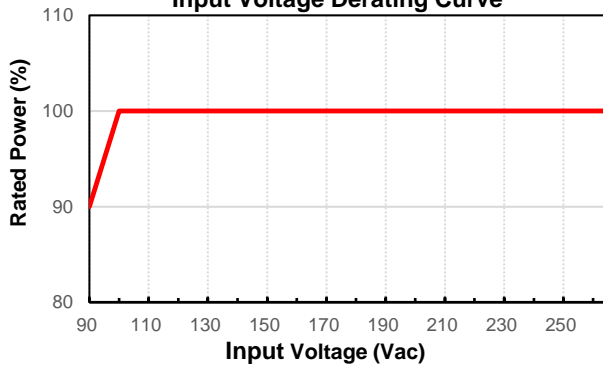

Performance Data

PDF700S120 (Eff Vs Io)

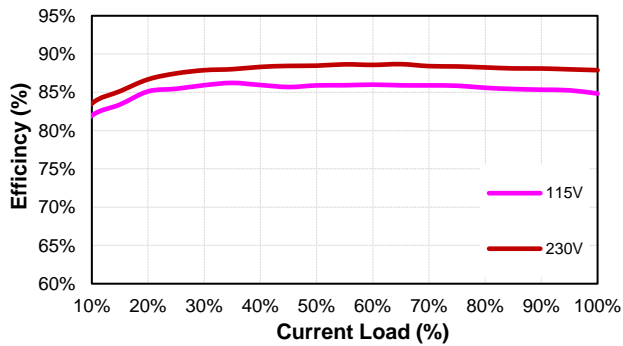

PDF700S240 (Eff Vs Io)

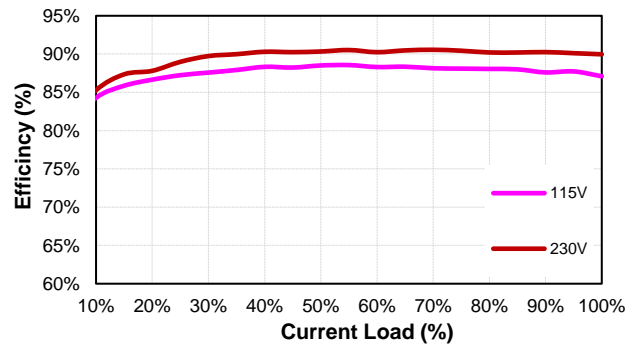

PDF700S280 (Eff Vs Io)

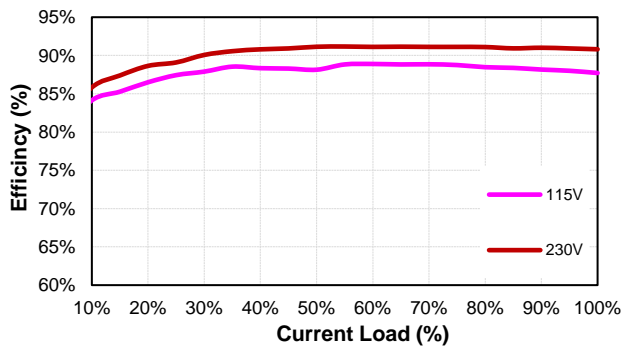

PDF700S480 (Eff Vs Io)

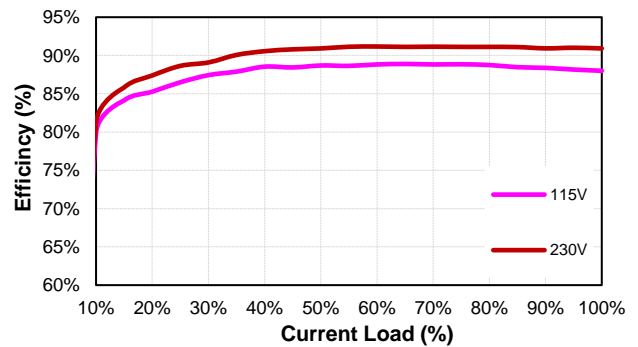

PDF700S560 (Eff Vs Io)

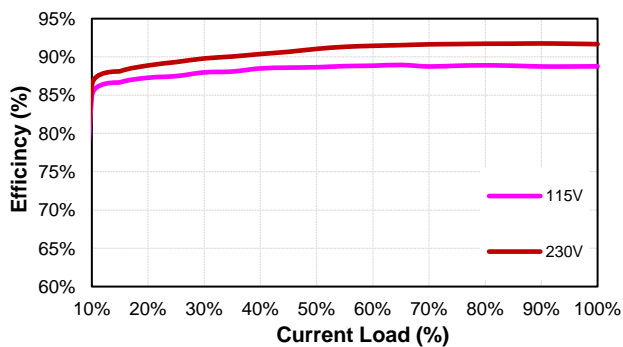



PDF700S Series

MECHANICAL SPECIFICATION

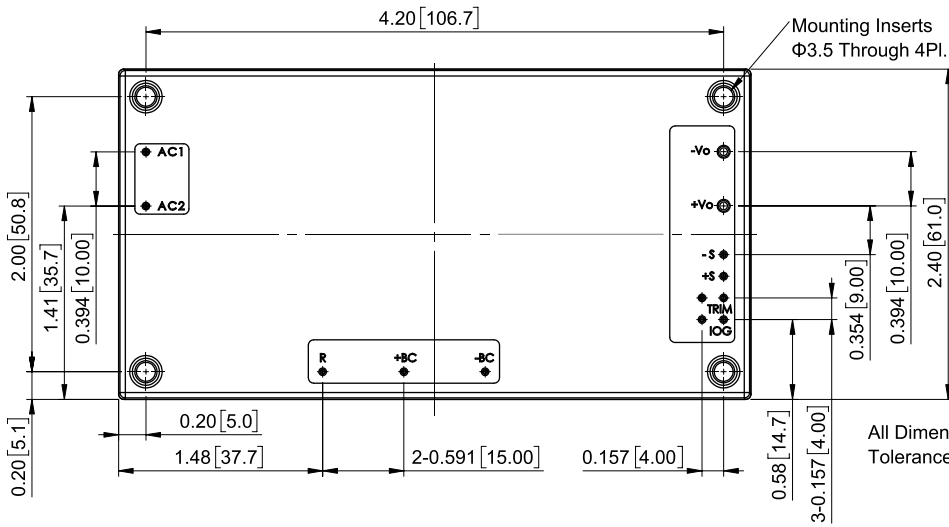

All Dimensions In Inches[mm]
 Tolerance Inches:x.xx = ±0.02 , x.xxx=± 0.010
 Millimeters:x.x = ±0.5, x.xx±0.25

Note:Pin Size is $\phi 0.04 \pm 0.004$ Inch [$\phi 1.0 \pm 0.1$ mm]
 Pin Size is $\phi 0.08 \pm 0.004$ Inch [$\phi 2.0 \pm 0.1$ mm]

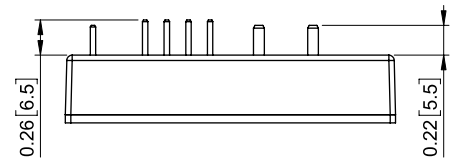
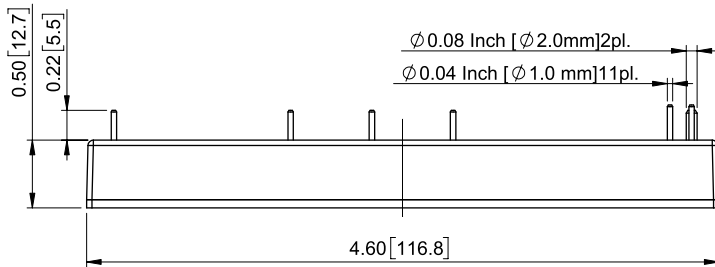

CINCON Electronics Co. Ltd.
 Add: 14F, No. 306, Sec.4, Hsin Yi Rd., Taipei, Taiwan
 Tel: 886-2-27086210
 Fax: 886-2-27029852
 E-mail: sales@cincon.com
 Web: www.cincon.com