

93.01

Approvals
(according to type):



RINA cULUS

UL US Certain relay/socket combinations

Screw terminal socket 35 mm (EN 60715) mounting

Supply voltage	Relay type	Socket type
12 V AC/DC	34.51.7.012.xx10	93.01.0.024
24 V AC/DC	34.51.7.024.xx10	93.01.0.024
48 V AC/DC	34.51.7.048.xx10	93.01.0.060
60 V AC/DC	34.51.7.060.xx10	93.01.0.060
(110...125)V AC/DC	34.51.7.060.xx10 or 34.81.7.060.xxxx	93.01.0.125
(220...240)V AC/DC	34.51.7.060.xx10 or 34.81.7.060.xxxx	93.01.0.240
(110...125)V AC/DC*	34.51.7.060.xx10 or 34.81.7.060.xxxx	93.01.3.125*
(220...240)V AC*	34.51.7.060.xx10 or 34.81.7.060.xxxx	93.01.3.240*
(220...240)V AC	34.51.7.060.xx10 or 34.81.7.060.xxxx	93.01.8.240
6 V DC	34.51.7.005.xx10 or 34.81.7.005.xxxx	93.01.7.024
12 V DC	34.51.7.012.xx10	93.01.7.024
24 V DC	34.51.7.024.xx10 or 34.81.7.024.xxxx	93.01.7.024
48 V DC	34.51.7.048.xx10	93.01.7.060
60 V DC	34.51.7.060.xx10 or 34.81.7.060.xxxx	93.01.7.060
Accessories		
20-way jumper link	093.20 (see specification next page)	
Plastic separator	093.01 (see specification next page)	
Sheet of marker tags	093.64 (see specification next page)	
Technical data		
Rated values	6A - 250 V	
Dielectric strength	6 kV (1.2/50 μs) between coil and contacts	
Protection category	IP 20	
Ambient temperature	(-40...+70)°C (U _N ≤ 60 V), (-40...+55)°C (U _N > 60 V)	
⊖ Screw torque	Nm	0.5
Wire strip length	mm	10
Max. wire size for 93.01 socket	solid wire	stranded wire
	mm ²	1x2.5 / 2x1.5
	AWG	1x14 / 2x16

* Leakage current suppression.

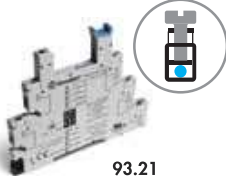
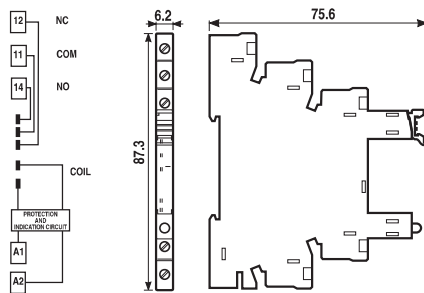

93.21

Approvals
(according to type):



Slim timed socket for 34 series (refer to 38 series data sheet for technical data)

Output	Supply voltage	Type of relay	Type of socket
1 pole 6A, electromechanical relay	12 V AC/DC	34.51.7.012.0010	93.21.0.024
1 pole 6A, electromechanical relay	24 V AC/DC	34.51.7.024.0010	93.21.0.024
1 output 2A 24 V DC, solid state relay	24 V AC/DC	34.81.7.024.9024	93.21.0.024
1 output 2A 240 V AC, solid state relay	24 V AC/DC	34.81.7.024.8240	93.21.0.024

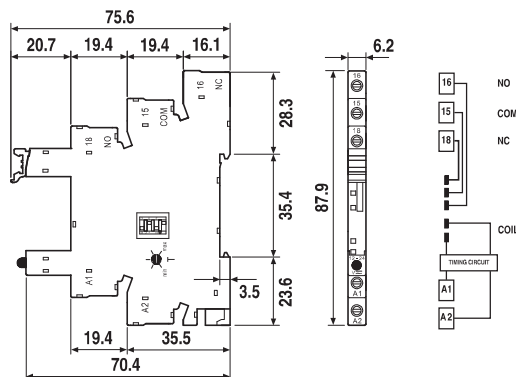

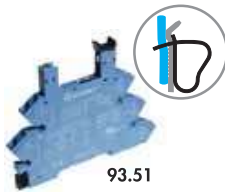

93.51
Approvals
(according to type):



US Certain relay/socket combinations

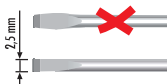

Screwless terminal socket 35 mm (EN 60715) mounting

Supply voltage	Relay type	Socket type
12 V AC/DC	34.51.7.012.xx10	93.51.0.024
24 V AC/DC	34.51.7.024.xx10	93.51.0.024
(110...125)V AC/DC	34.51.7.060.xx10 or 34.81.7.060.xxxx	93.51.0.125
(220...240)V AC/DC	34.51.7.060.xx10 or 34.81.7.060.xxxx	93.51.0.240
(110...125)V AC/DC*	34.51.7.060.xx10 or 34.81.7.060.xxxx	93.51.3.125*
(220...240)V AC*	34.51.7.060.xx10 or 34.81.7.060.xxxx	93.51.3.240*
12 V DC	34.51.7.012.xx10	93.51.8.240
24 V DC	34.51.7.024.xx10 or 34.81.7.024.xxxx	93.51.7.024
60 V DC	34.51.7.060.xx10 or 34.81.7.060.xxxx	93.51.7.060

Accessories

20-way jumper link	093.20 (see table below)
Plastic separator	093.01 (see table below)
Sheet of marker tags	093.64 (see table below)

Technical data

Rated values	6A - 250 V		
Dielectric strength	6 kV (1.2/50 μs) between coil and contacts		
Protection category	IP 20		
Ambient temperature	(-40...+70)°C (U _N ≤ 60 V), (-40...+55)°C (U _N > 60 V)		
Wire strip length	mm	10	
Max. wire size for 93.51 socket	solid wire	stranded wire	
	mm ²	1x2.5	1x2.5
	AWG	1x14	1x14

* Leakage current suppression.

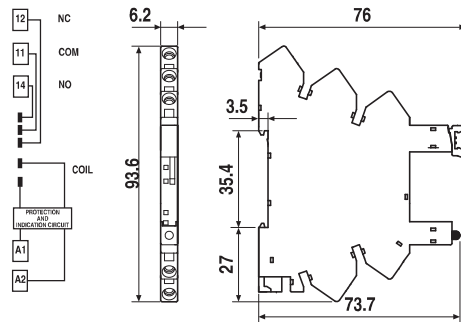

Accessories



093.20

Approvals
(according to type):



20-way jumper link for 93.01 and 93.51 sockets

Rated values	093.20 (blue)	093.20.0 (black)
	36 A - 250 V	

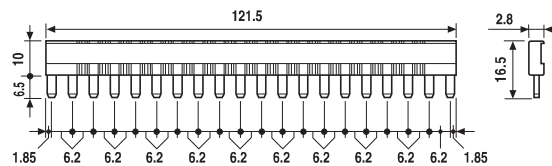

093.01

Plastic separator for 93.01 and 93.51 sockets

093.01

Thickness 2 mm, required at the start and the end of a group of interfaces.

Can be used for visual separation of groups. Must be used for:

- protective separation of different voltages of neighbouring PLC interfaces according to VDE 0106-101
- protection of cut jumper links

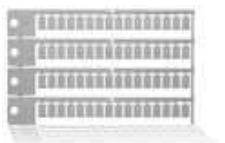

093.64

Sheet of marker tags, plastic, 64 tags, 6x10 mm

093.64

for 93.01 and 93.51 sockets



93.11

Approvals
(according to type):



PCB socket with retaining and release clip	93.11 (blue)
For relay type	34.51, 34.81
Technical data	
Rated values	6 A - 250 V
Dielectric strength	≥ 6 kV (1.2/50 μs) between coil and contacts
Protection category	IP 20
Ambient temperature	°C -40...+70

Retaining and release clip use:

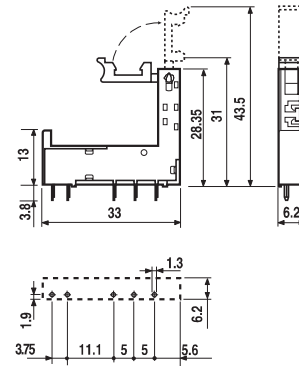
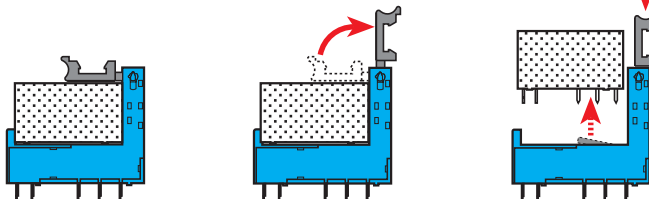

Copper side view

