



CERAMIC

# Bandpass Filter

## BFHK-3142+

Mini-Circuits

50Ω 28 to 36 GHz

### THE BIG DEAL

- Ultra-High Stopband Rejection Structure – 75 dB typical
- Surface mountable pick and place standard case style
- Standard small 1812 (4.5mm x 3.2mm) case style
- High quality distributed filter topology
- Wide rejection band
- Shielded construction preventing filter from de-tuning
- Reduced footprint area by employing LGA (land grid array)
- Suited for very high-volume production
- Patent Pending



Generic photo used for illustration purposes only

CASE STYLE: NM1812C-3

**+RoHS Compliant**

The +Suffix identifies RoHS Compliance. See our website for methodologies and qualifications

### APPLICATIONS

- Test and Measurement
- Aerospace and Defense Signal Conditioning

### PRODUCT OVERVIEW

The BFHK-3142+ LTCC Band Pass Filter achieves a miniature size and high repeatability of performance by utilizing a proprietary LTCC material system and distributed filter topology. The passband loss at 28 – 36 GHz is as low as 2.8 dB, with typical stopband rejections at 75 dB up to 54 GHz and 40 dB up to 67 GHz. This model handles up to 1W RF input power, and provides a wide operating temperature range from -55 to +125°C. Utilizing a proprietary LTCC material system and a distributed filter topology, this filter is able to achieve repeatable performance on a lot-to-lot basis.

### KEY FEATURES

Feature	Advantages
Ultra-High Rejection	Typical stopband rejections at 75 dB up to 54 GHz and 40 dB up to 67 GHz
Cost effective	LTCC is scalable technology that is cost effective due to ease of production in high quantities.
Small size (4.5mm x 3.2mm)	Allows for high layout density of circuit boards, while minimizing effects of parasitics.
Surface Mountable	Suitable for very high volume automated assembly process.

REV. A  
 ECO-022343  
 BFHK-3142+  
 MCL NY  
 240731





CERAMIC

# Bandpass Filter

## BFHK-3142+

### ELECTRICAL SPECIFICATIONS<sup>1</sup> AT 25°C

Parameter	F#	Frequency (GHz)		Min.	Typ.	Max.	Units	
Center Frequency	—	—	—	—	31.7	—	GHz	
Pass Band	Insertion Loss	F1-F2	28	36	—	2.8	4.0	dB
	Return Loss	F1-F2	28	36	—	8.0	—	dB
Stop Band, Lower	Insertion Loss	DC-F3	0.1	20	70	85	—	dB
Stop Band, Upper	Insertion Loss	F4-F5	44	54	60	75	—	dB
			54	67	30	40	—	

1. Measured on Mini-Circuits Test Board TB-BFHK-3142C+ with connectors and feedlines de-embedded.

### MAXIMUM RATINGS

Parameter	Ratings
Operating Temperature	-55°C to 125°C
Storage Temperature	-55°C to 125°C
RF Power Input	1W max.

Permanent damage may occur if any of these limits are exceeded.

### TYPICAL FREQUENCY RESPONSE

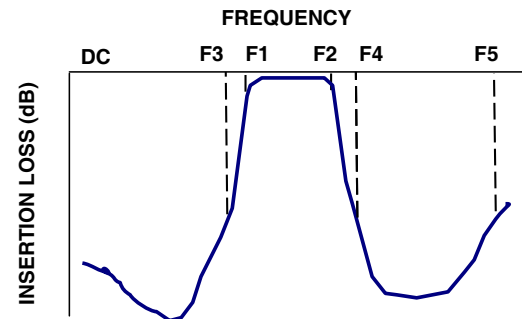

### FUNCTIONAL SCHEMATIC

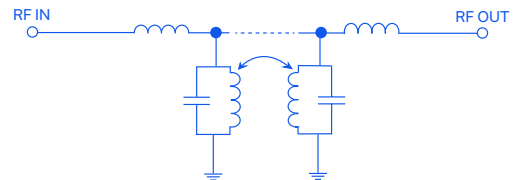



CERAMIC

# Bandpass Filter

# BFHK-3142+

## EVALUATION BOARD MCL P/N: TB-BFHK-3142C+ SUGGESTED PCB LAYOUT: PL-730

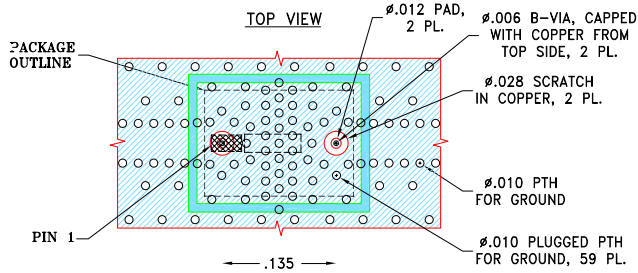

### STACK-UP DIAGRAM

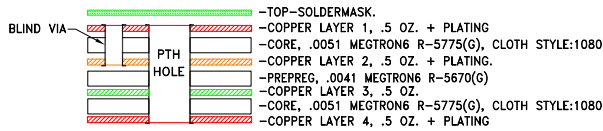

- TOTAL FINISHED THICKNESS 0.0228±.004.
- B-VIA PRESENT FROM COPPER LAYER 1 TO COPPER LAYER 2.
- PTH PRESENT FROM COPPER LAYER 1 TO COPPER LAYER 4.
- INDICATED PLUGGED PTH'S ARE PLUGGED WITH EPOXY AND CAPPED WITH COPPER FROM TOP SIDE.
- LAYER 4 IS CONTINUOUS GROUND PLANE.

### NOTES:

- PCB IS MULTILAYER PCB, SEE STACK-UP DIAGRAM.
- TRACE WIDTH & GAP PARAMETERS ARE SHOWN FOR MEGTRON6 R-5775(G), CLOTH STYLE:1080 WITH DIELECTRIC THICKNESS .0051; COPPER: 1/2 OZ.+PLATING. FOR OTHER MATERIALS TRACE WIDTH AND GAP MAY NEED TO BE MODIFIED.
- COPPER LAYER 4 OF THE PCB ARE CONTINUOUS GROUND PLANE.

- DENOTES PCB COPPER LAYOUT WITH SMOBC (SOLDER MASK OVER BARE COPPER)
- DENOTES COPPER LAND PATTERN FREE OF SOLDER MASK

## PAD CONNECTIONS

INPUT	1
OUTPUT	2
GROUND	3

## PRODUCT MARKING: F473

## OUTLINE DRAWING

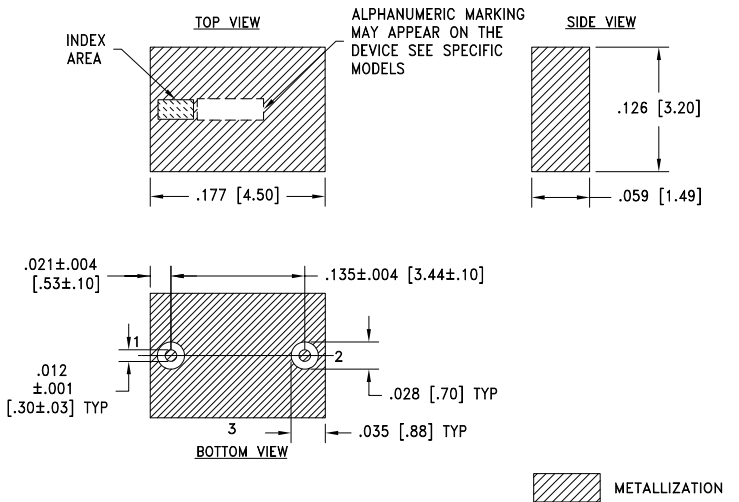

Weight: .126 grams.  
 Dimensions are in inches [mm]. Tolerances: 2 Pl. ±.01; 3 Pl. ±.005 Inches

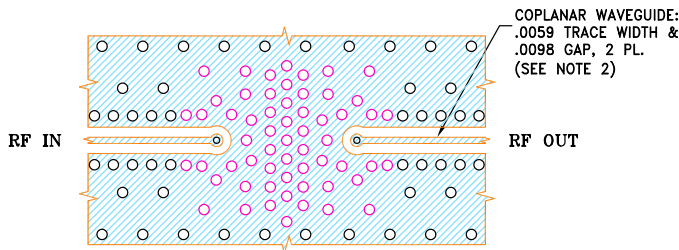

### LAYER 3 & PTH

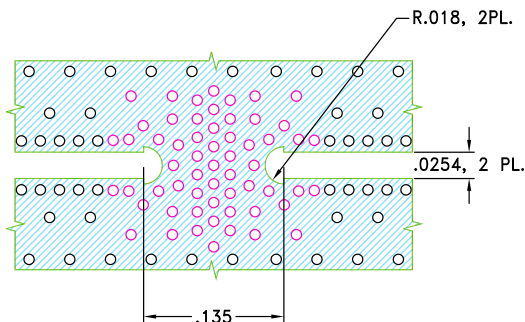



CERAMIC

# Bandpass Filter

# BFHK-3142+

### TYPICAL PERFORMANCE DATA

Frequency (MHz)	Insertion Loss (dB)	Return Loss (dB)
25	101.18	0.01
100	103.28	0.00
1000	111.44	0.02
2000	114.07	0.17
6000	113.29	0.01
8000	120.13	0.12
10000	113.38	0.14
12000	112.16	0.11
14000	113.19	0.02
16000	114.74	0.21
18000	103.80	0.15
20000	92.64	0.03
22000	77.66	0.16
24000	58.04	0.02
28000	1.29	30.54
31700	1.71	10.16
36000	1.60	25.39
44000	86.68	0.30
54000	89.22	0.40
67000	65.47	6.17

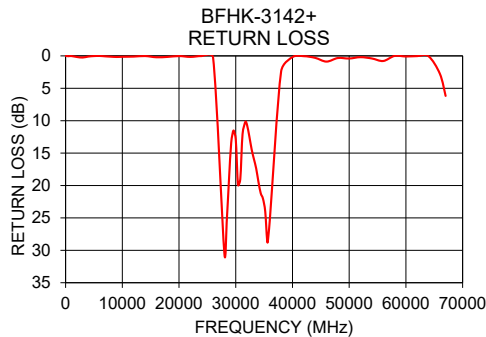
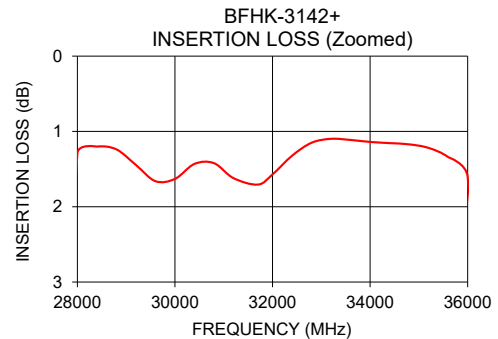
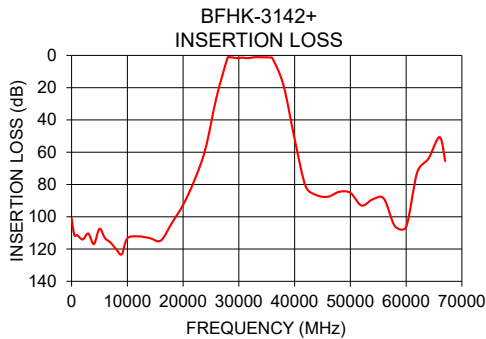

- NOTES**
- A. Performance and quality attributes and conditions not expressly stated in this specification document are intended to be excluded and do not form a part of this specification document.
  - B. Electrical specifications and performance data contained in this specification document are based on Mini-Circuit's applicable established test performance criteria and measurement instructions.
  - C. The parts covered by this specification document are subject to Mini-Circuits standard limited warranty and terms and conditions (collectively, "Standard Terms"); Purchasers of this part are entitled to the rights and benefits contained therein. For a full statement of the standard. Terms and the exclusive rights and remedies thereunder, please visit Mini-Circuits' website at [www.minicircuits.com/terms/viewterm.html](http://www.minicircuits.com/terms/viewterm.html)

