



信昌電子陶瓷股份有限公司

**Prosperity Dielectrics Co., Ltd.**

No.566-1, Kaoshi Rd., Yangmei, Taoyuan 32668, Taiwan (R.O.C.)

Tel : 886-3-4753355

Fax : 886-3-4854959

**Messrs. :** 一般共用

**Date :** 2023/04/07

# APPROVAL SHEET

**Product Name :** General Purpose Multilayer Ceramic Chip Capacitors

**Part No. :** FN Series

**Description :** Size 01R5~2225, C0G/X7R/X7S/X6S/X5R, UR≤50V

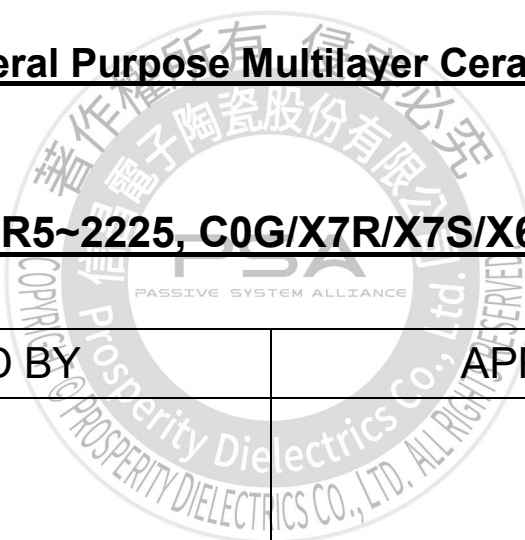

PREPARED BY	APPROVED BY

信昌電子陶瓷股份有限公司

PROSPERITY DIELECTRICS CO., LTD.

桃園市楊梅區高獅路 566-1 號 <http://www.pdc.com.tw>

**Tel :** 03-4753355 ext :

**Fax :** 03-4854959

**Contactor :** \_\_\_\_\_ **Mobile :** \_\_\_\_\_



信昌電子陶瓷股份有限公司

# Prosperity Dielectrics Co., Ltd.

No.566-1, Kaoshi Rd., Yangmei, Taoyuan 32668, Taiwan (R.O.C.)

Tel : 886-3-4753355

Fax : 886-3-4854959

# SPECIFICATION

## FOR

**Product Name : General Purpose Multilayer Ceramic Chip Capacitors**

**Part No. : FN Series**

**Description : Size 01R5~2225, C0G/X7R/X7S/X6S/X5R, U<sub>R</sub>≤50V**

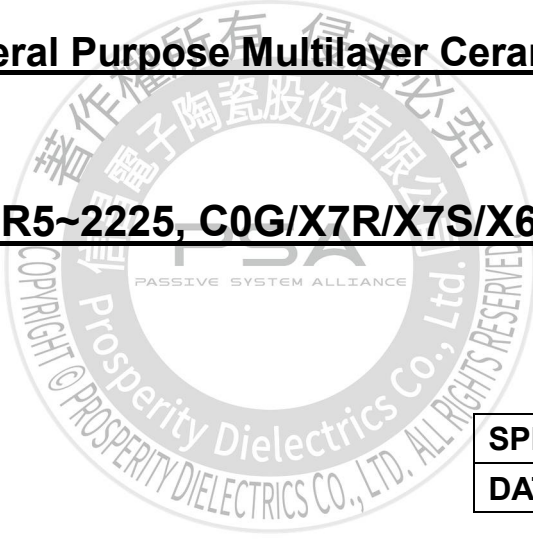

<b>SPEC. No. : FN-000-001-21</b>
<b>DATE : 2023/04/07</b>

<b>DRAWN BY</b>	<b>CHECEKED BY</b>	<b>APPROVED BY</b>
<i>Jane Hsiao</i>	<i>Yvens Chou</i>	<i>Jason Lin</i>

## 1. INTRODUCTION

POSPERITY Multilayer Ceramic Chip Capacitors supplied in bulk or tape & reel package are ideally suitable for thick-film hybrid circuits and automatic surface mounting on any printed circuit boards.

The nickel-barrier terminations are consisted of a nickel barrier layer over the silver metallization and then finished by electroplated solder layer to ensure the terminations have good solderability. The nickel barrier layer in terminations prevents the dissolution of termination when extended immersion in molten solder at elevated solder temperature.

## 2. FEATURES

- a. A wide selection of sizes is available (0201 to 2225).
- b. High capacitance in given case size.
- c. Capacitor with lead-free termination (pure Tin).
- d. RoHS & HALOGEN compliant.

## 3. APPLICATIONS

- a. For general digital circuit.
- b. For power supply bypass capacitors.
- c. For consumer electronics.
- d. For telecommunication.
- e. DC to DC converter.

## 4. HOW TO ORDER

<u>FN</u>	<u>21</u>	<u>X</u>	<u>471</u>	<u>K</u>	<u>500</u>	<u>P</u>	<u>X</u>	<u>G</u>
PDC Family	Size	Dielectric	Capacitance	Tolerance	Rated Voltage	Packaging	Thickness	Control Code
Table 1	Table 2	Table 3	Table 4	Table 5	Table 6	Table 7	Table 8	Table 9

Table 1		PDC Family	
Code	Description	Code	Description
FN	General purpose product ≤50Vdc		

Table 6		Rated Voltage			
Code	Description	Code	Description	Code	Description
4R0	4.0Vdc	100	10Vdc	250	25Vdc
6R3	6.3Vdc	160	16Vdc	500	50Vdc

Table 2		General Purpose			
Code	Description	Code	Description	Code	Description
02	01R5 (0402)	31	1206 (3216)	52	2211 (5728)
03	0201 (0603)	32	1210 (3225)	55	2220 (5750)
15	0402 (1005)	42	1808 (4520)	56	2225 (5763)
18	0603 (1608)	43	1812 (4532)		
21	0805 (2012)	46	1825 (4563)		

Table 3		Dielectric Material Characteristics			
Code	Description	Code	Description	Code	Description
N	C0G	X	X7R	S	X6S
B	X5R	A	X7S		

Table 7		Packaging Type			
Code	Description	Code	Description	Code	Description
B	Bulk	T	Tray package		
E	Tape and 7" Reel, Embossed Tape	P	Tape and 7" Reel, Paper Tape		
K	Tape and 10" Reel, Embossed Tape	D	Tape and 10" Reel, Paper Tape		
L	Tape and 13" Reel, Embossed Tape	G	Tape and 13" Reel, Paper Tape		

Table 4		Capacitance Rule Code			
Code	Description	Code	Description	Code	Description
R47	0.47pF	102	102=10x10 <sup>2</sup> =1000pF		
0R5	0.5pF	104	104=10x10 <sup>4</sup> =100nF		
100	100=10x10 <sup>0</sup> =10pF	106	106=10x10 <sup>6</sup> =10μF		

Table 8		Thickness Description			
Code	Description	Code	Description	Code	Description
A	0.60 ± 0.10 mm	I	1.25 ± 0.20 mm	Q	0.50 +0.02/-0.05 mm
B	0.8 ± 0.15/-0.10 mm	J	1.15 ± 0.15 mm	R	3.10 ± 0.30 mm
C	1.25 ± 0.10 mm	K	0.50 ± 0.20 mm	S	0.80 ± 0.07 mm
D	1.40 ± 0.15 mm	L	0.30 ± 0.03 mm	T	0.85 ± 0.10 mm
E	1.60 ± 0.20 mm	M	0.95 ± 0.10 mm	U	0.50 ± 0.10 mm
F	2.00 ± 0.20 mm	N	0.50 ± 0.05 mm	V	0.20 ± 0.02 mm
G	2.50 ± 0.30 mm	O	3.50 ± 0.20 mm	X	0.80 ± 0.10 mm
H	2.80 ± 0.30 mm	P	1.60 +0.3/-0.10 mm	Z	0.25 ± 0.03 mm

Table 5		Tolerance			
Code	Description	Code	Description	Code	Description
A	±0.05 pF	I	-10% ~ 0%	Q	±0.03 pF
B	±0.10 pF	J	±5 %	Z	-20% ~ +80%
C	±0.25 pF	K	±10 %	X	+10% ~ +20%
D	±0.50 pF	L	0% ~ +10%		
F	±1 %	M	±20 %		
G	±2 %	N	-5% ~ +10%		
H	±3 %	P	±0.02 pF		

Table 9		Special Control Code	
Code	Description	Code	Description
G	RoHS Compliant		

5. EXTERNAL DIMENSIONS

Size Inch (mm)	L (mm)	W (mm)	Code / T (mm)	M <sub>B</sub> (mm)
01R5(0402)	0.40±0.02	0.20±0.02	See No.4 Reference Table 8	0.10±0.03
0201(0603)	0.60±0.03	0.30±0.03		0.15±0.05
	0.60±0.05 (Cap.≥0.68μF)	0.30±0.05 (Cap.≥0.68μF)		
0402(1005)	1.00±0.10	0.50±0.10		0.25 +0.05/-0.10
	1.00±0.20 <sup>#1</sup>	0.50±0.20 <sup>#1</sup>		
0603(1608)	1.60±0.15	0.80±0.15		0.40±0.15
0805(2012)	2.00±0.20	1.25±0.20		0.50±0.20
1206(3216)	3.20±0.20	1.60±0.20		0.60±0.20
	3.20 +0.30/-0.10 <sup>#2</sup>	1.60 +0.30/-0.10 <sup>#2</sup>		
1210(3225)	3.20±0.30	2.50±0.30		0.75±0.35
1808(4520)	4.50±0.40	2.00±0.25		0.75±0.35
1812(4532)	4.50±0.40	3.20±0.30		0.75±0.35
1825(4563)	4.50±0.40	6.30±0.40		0.75±0.35
2220(5750)	5.70±0.40	5.00±0.40		0.85±0.35
2225(5763)	5.70±0.40	6.30±0.40	0.85±0.35	

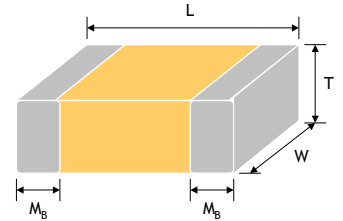

Fig. 5.1 The outline of MLCC

<sup>#1</sup> For 0402 size K thickness products. <sup>#2</sup> For 1206 size P thickness products.

6. GENERAL ELECTRICAL DATA

Dielectric	C0G	X7R	X5R	X6S	X7S
Size	01R5, 0201, 0402, 0603, 0805, 1206, 1210, 1808, 1812, 1825, 2220, 2225	01R5, 0201, 0402, 0603, 0805, 1206, 1210, 1812, 1825, 2220, 2225	01R5, 0201, 0402, 0603	0201, 0402	0201
Rated voltage (WVDC)	10V, 16V, 25V, 50V	6.3V, 10V, 16V, 25V, 50V	4V, 6.3V, 10V, 16V, 25V, 50V	4V, 6.3V, 10V, 16V, 25V	10V
Capacitance range*	0R1 to 100nF	100pF to 820nF	100pF to 820nF	100nF to 470nF	100nF
Capacitance tolerance**	B(±0.1pF), C(±0.25pF), D(±0.5pF), F(±1%), G(±2%), J(±5%), K(±10%)	J(±5%), K(±10%), M(±20%)		K(±10%), M(±20%)	
Tan δ*	Cap.<30pF : Q≥400+20C Cap.≥30pF : Q≥1000	Note 1			
Operating temperature	-55 to +125°C		-55 to +85°C	-55 to +105°C	-55 to +125°C
Capacitance characteristic	±30ppm/°C	±15%		±22%	±22%
Termination	Cu/Ni/Sn (lead-free termination)				

\* Measured at the condition of 30~70% related humidity.

C0G : Apply 1.0±0.2Vrms, 1.0MHz±10% for Cap.≤1000pF and 1.0±0.2Vrms, 1.0KHz±10% for Cap.>1000pF, 25°C at ambient temperature.

X7R/X5R/X7S/X6S : Apply 1.0±0.2Vrms, 1.0KHz±10%, at 25°C ambient temperature.

\*\* Preconditioning for Class II MLCC : Perform a heat treatment at 150±10°C for 1 hour, then leave in ambient condition for 24±2 hours before measurement.

Note 1 : X7R/X5R/X6S/X7S

Rated	D.F.≤	Exception of D.F.≤
50V	≤2.5%	≤3.5% 0201(50V), 0603≥0.047μF, 0805≥0.1μF, 1206≥0.47μF
		≤5% 0201≥0.01μF,
		≤10% 0402≥0.012μF, 0603>0.1μF
25V	≤3.5%	≤5% 0201≥0.01μF
		≤7% 0603≥0.33μF
		≤10% 0201≥0.1μF, 0402≥0.10μF, 0603≥0.47μF
		≤12.5% 0402≥0.47μF
16V	≤3.5%	≤5% 0201≥0.01μF, 0402≥0.033μF, 0603≥0.15μF, 0805≥0.68μF,
		≤10% 0201≥0.1μF(0201/X7R≥0.022μF), 0402≥0.22μF, 0603≥0.68μF,
10V	≤5%	≤10% 0201≥0.012μF, 0402≥0.33μF(0402/X7R≥0.22μF), 0603≥0.33μF,
6.3V	≤10%	≤15% 0201≥0.1μF
4V	≤15%	---
10V	≤5%	---
6.3V,10V	≤10%	---

7. CAPACITANCE RANGE

7-1. C0G

Cap(pF)	EIA Size Code	0201				0402				0603				0805				1206				
		10V	16V	25V	50V	10V	16V	25V	50V	10V	16V	25V	50V	10V	16V	25V	50V	10V	16V	25V	50V	
0.1	0R1	L	L	L	L	N	N	N	N													
0.2	0R2	L	L	L	L	N	N	N	N													
0.3	0R3	L	L	L	L	N	N	N	N	S	S	S	S									
0.4	0R4	L	L	L	L	N	N	N	N	S	S	S	S									
0.5	0R5	L	L	L	L	N	N	N	N	S	S	S	S	A	A	A	A					
0.6	0R6	L	L	L	L	N	N	N	N	S	S	S	S	A	A	A	A					
0.7	0R7	L	L	L	L	N	N	N	N	S	S	S	S	A	A	A	A					
0.8	0R8	L	L	L	L	N	N	N	N	S	S	S	S	A	A	A	A					
0.9	0R9	L	L	L	L	N	N	N	N	S	S	S	S	A	A	A	A					
1.0	1R0	L	L	L	L	N	N	N	N	S	S	S	S	A	A	A	A					X
1.0	1R0	L	L	L	L	N	N	N	N	S	S	S	S	A	A	A	A					X
1.2	1R2	L	L	L	L	N	N	N	N	S	S	S	S	A	A	A	A	X	X	X	X	X
1.5	1R5	L	L	L	L	N	N	N	N	S	S	S	S	A	A	A	A	X	X	X	X	X
1.8	1R8	L	L	L	L	N	N	N	N	S	S	S	S	A	A	A	A	X	X	X	X	X
2.2	2R2	L	L	L	L	N	N	N	N	S	S	S	S	A	A	A	A	X	X	X	X	X
2.7	2R7	L	L	L	L	N	N	N	N	S	S	S	S	A	A	A	A	X	X	X	X	X
3.3	3R3	L	L	L	L	N	N	N	N	S	S	S	S	A	A	A	A	X	X	X	X	X
3.9	3R9	L	L	L	L	N	N	N	N	S	S	S	S	A	A	A	A	X	X	X	X	X
4.7	4R7	L	L	L	L	N	N	N	N	S	S	S	S	A	A	A	A	X	X	X	X	X
5.6	5R6	L	L	L	L	N	N	N	N	S	S	S	S	A	A	A	A	X	X	X	X	X
6.8	6R8	L	L	L	L	N	N	N	N	S	S	S	S	A	A	A	A	X	X	X	X	X
8.2	8R2	L	L	L	L	N	N	N	N	S	S	S	S	A	A	A	A	X	X	X	X	X
10	100	L	L	L	L	N	N	N	N	S	S	S	S	A	A	A	A	X	X	X	X	X
12	120	L	L	L	L	N	N	N	N	S	S	S	S	A	A	A	A	X	X	X	X	X
15	150	L	L	L	L	N	N	N	N	S	S	S	S	A	A	A	A	X	X	X	X	X
18	180	L	L	L	L	N	N	N	N	S	S	S	S	A	A	A	A	X	X	X	X	X
22	220	L	L	L	L	N	N	N	N	S	S	S	S	A	A	A	A	X	X	X	X	X
27	270	L	L	L	L	N	N	N	N	S	S	S	S	A	A	A	A	X	X	X	X	X
33	330	L	L	L	L	N	N	N	N	S	S	S	S	A	A	A	A	X	X	X	X	X
39	390	L	L	L	L	N	N	N	N	S	S	S	S	A	A	A	A	X	X	X	X	X
47	470	L	L	L	L	N	N	N	N	S	S	S	S	A	A	A	A	X	X	X	X	X
56	560	L	L	L	L	N	N	N	N	S	S	S	S	A	A	A	A	X	X	X	X	X
68	680	L	L	L	L	N	N	N	N	S	S	S	S	A	A	A	A	X	X	X	X	X
82	820	L	L	L	L	N	N	N	N	S	S	S	S	A	A	A	A	X	X	X	X	X
100	101	L	L	L	L	N	N	N	N	S	S	S	S	A	A	A	A	X	X	X	X	X
120	121	L	L	L	L	N	N	N	N	S	S	S	S	A	A	A	A	X	X	X	X	X
150	151	L	L	L	L	N	N	N	N	S	S	S	S	A	A	A	A	X	X	X	X	X
180	181	L	L	L	L	N	N	N	N	S	S	S	S	A	A	A	A	X	X	X	X	X
220	221	L	L	L	L	N	N	N	N	S	S	S	S	A	A	A	A	X	X	X	X	X
270	271			L		N	N	N	N	S	S	S	S	A	A	A	A	X	X	X	X	X
330	331					N	N	N	N	S	S	S	S	A	A	A	A	X	X	X	X	X
390	391			L		N	N	N	N	S	S	S	S	X	X	X	X	X	X	X	X	X
470	471			L		N	N	N	N	S	S	S	S	X	X	X	X	X	X	X	X	X
560	561					N	N	N	N	S	S	S	S	X	X	X	X	X	X	X	X	X
680	681					N	N	N	N	S	S	S	S	X	X	X	X	X	X	X	X	X
820	821					N	N	N	N	S	S	S	S	X	X	X	X	X	X	X	X	X
1000	102					N	N	N	N	S	S	S	S	X	X	X	X	X	X	X	X	X
1200	122									B	B	B	B	X	X	X	X	X	X	X	X	X
1500	152									B	B	B	B	X	X	X	X	X	X	X	X	X
1800	182									B	B	B	B	X	X	X	X	X	X	X	X	X
2200	222									B	B	B	B	X	X	X	X	X	X	X	X	X
2700	272									B	B	B	B	C	C	C	C	X	X	X	X	X
3300	332									B	B	B	B	C	C	C	C	X	X	X	X	X
3900	392									B	B	B	B	C	C	C	C	X	X	X	X	X
4700	472									B	B	B	B	C	C	C	C	X	X	X	X	X
5600	562									B	B	B	B	C	C	C	C	X	X	X	X	X
6800	682									B	B	B	B	C	C	C	C	C	C	C	C	C
8200	822									B	B	B	B	C	C	C	C	C	C	C	C	C
10000	103									B	B	B	B	C	C	C	C	C	C	C	C	C
12000	123													T/C	T/C	T/C	C	P	P	P	P	P
15000	153													C	C	C	C	P	P	P	P	P
18000	183													C	C	C	C	P	P	P	P	P
22000	223													C	C	C	C	P	P	P	P	P
27000	273																	P	P	P	P	P
33000	333																	P	P	P	P	P
39000	393																	P	P	P	P	P
47000	473																	P	P	P	P	P
56000	563																	P	P	P	P	P
68000	683																	P	P	P	P	P
82000	823																	P	P	P	P	P
100000	104																	E/P	E/P	E/P	E/P	E/P

7. CAPACITANCE RANGE(Con.)

7-1. C0G

Cap(pF)	EIA Size Code	1210				1808		1812				1825		2220		2225	
		10V	16V	25V	50V	25V	50V	10V	16V	25V	50V	25V	50V	25V	50V	25V	50V
2.2	2R2					C	C										
2.7	2R7					C	C										
3.3	3R3					C	C										
3.9	3R9					C	C										
4.7	4R7					C	C										
5.6	5R6					C	C										
6.8	6R8					C	C										
8.2	8R2					C	C										
10	100	M	M	M	M	C	C	C	C	C	C	F	F	F	F	F	F
12	120	M	M	M	M	C	C	C	C	C	C	F	F	F	F	F	F
15	150	M	M	M	M	C	C	C	C	C	C	F	F	F	F	F	F
18	180	M	M	M	M	C	C	C	C	C	C	F	F	F	F	F	F
22	220	M	M	M	M	C	C	C	C	C	C	F	F	F	F	F	F
27	270	M	M	M	M	C	C	C	C	C	C	F	F	F	F	F	F
33	330	M	M	M	M	C	C	C	C	C	C	F	F	F	F	F	F
39	390	M	M	M	M	C	C	C	C	C	C	F	F	F	F	F	F
47	470	M	M	M	M	C	C	C	C	C	C	F	F	F	F	F	F
56	560	M	M	M	M	C	C	C	C	C	C	F	F	F	F	F	F
68	680	M	M	M	M	C	C	C	C	C	C	F	F	F	F	F	F
82	820	M	M	M	M	C	C	C	C	C	C	F	F	F	F	F	F
100	101	M	M	M	M	C	C	C	C	C	C	F	F	F	F	F	F
120	121	M	M	M	M	C	C	C	C	C	C	F	F	F	F	F	F
150	151	M	M	M	M	C	C	C	C	C	C	F	F	F	F	F	F
180	181	M	M	M	M	C	C	C	C	C	C	F	F	F	F	F	F
220	221	M	M	M	M	C	C	C	C	C	C	F	F	F	F	F	F
270	271	M	M	M	M	C	C	C	C	C	C	F	F	F	F	F	F
330	331	M	M	M	M	C	C	C	C	C	C	F	F	F	F	F	F
390	391	M	M	M	M	C	C	C	C	C	C	F	F	F	F	F	F
470	471	M	M	M	M	C	C	C	C	C	C	F	F	F	F	F	F
560	561	M	M	M	M	C	C	C	C	C	C	F	F	F	F	F	F
680	681	M	M	M	M	C	C	C	C	C	C	F	F	F	F	F	F
820	821	M	M	M	M	C	C	C	C	C	C	F	F	F	F	F	F
1000	102	M	M	M	M	C	C	C	C	C	C	F	F	F	F	F	F
1200	122	M	M	M	M	C	C	C	C	C	C	F	F	F	F	F	F
1500	152	M	M	M	M	C	C	C	C	C	C	F	F	F	F	F	F
1800	182	M	M	M	M	C	C	C	C	C	C	F	F	F	F	F	F
2200	222	M	M	M	M	C	C	C	C	C	C	F	F	F	F	F	F
2700	272	M	M	M	M	C	C	C	C	C	C	F	F	F	F	F	F
3300	332	M	M	M	M	C	C	C	C	C	C	F	F	F	F	F	F
3900	392	M	M	M	M	C	C	C	C	C	C	F	F	F	F	F	F
4700	472	M	M	M	M	C	C	C	C	C	C	F	F	F	F	F	F
5600	562	M	M	M	M	C	C	C	C	C	C	F	F	F	F	F	F
6800	682	M	M	M/C	M/C	C	C	C	C	C	C	F	F	F	F	F	F
8200	822	M	M	M/C	M/C	C	C	C	C	C	C	F	F	F	F	F	F
10000	103	M	M	M/C	M/C	C	C	C	C	C	C	F	F	F	F	F	F
12000	123	C	C	C/E	C/E	E	E	C	C	C	C	F	F	F	F	F	F
15000	153	C	C	C/E	C/E	E	E	C	C	C	C	F	F	F	F	F	F
18000	183	F	F	F	F	F	F	C	C	C	C	F	F	F	F	F	F
22000	223	F	F	F	F	F	F	C	C	C	C	F	F	F	F	F	F
27000	273	F	F	F/G	F/G			C	C	E	E	F	F	F	F	F	F
33000	333	F	F	F/G	F/G			C	C	E	E	F	F	F	F	F	F
39000	393	F	F	F/G	F/G			G	G	G	G	F	F	F	F	F	F
47000	473	F	F	F/G	F/G			G	G	G	G	F	F	F	F	F	F
56000	563							G	G	G	G	F	F	F	F	F	F
68000	683							G	G	G	G	F	F	F	F	F	F
82000	823							G	G	G	G	F	F	F	F	F	F
100000	104							G	G	G	G	G	G	G	F	F	F



**7. CAPACITANCE RANGE(Con.)**

**7-2. X7R**

Cap(pF)	EIA Size		0201					0402					0603					0805				
	Code		6.3V	10V	16V	25V	50V	6.3V	10V	16V	25V	50V	6.3V	10V	16V	25V	50V	6.3V	10V	16V	25V	50V
100	101				L	L	L		N	N	N	N		S	S	S	S		X	X	X	X
120	121				L	L	L		N	N	N	N		S	S	S	S		X	X	X	X
150	151				L	L	L		N	N	N	N		S	S	S	S		X	X	X	X
180	181				L	L	L		N	N	N	N		S	S	S	S		X	X	X	X
220	221				L	L	L		N	N	N	N		S	S	S	S		X	X	X	X
270	271				L	L	L		N	N	N	N		S	S	S	S		X	X	X	X
330	331				L	L	L		N	N	N	N		S	S	S	S		X	X	X	X
390	391				L	L	L		N	N	N	N		S	S	S	S		X	X	X	X
470	471				L	L	L		N	N	N	N		S	S	S	S		X	X	X	X
560	561				L	L	L		N	N	N	N		S	S	S	S		X	X	X	X
680	681				L	L	L		N	N	N	N		S	S	S	S		X	X	X	X
820	821				L	L	L		N	N	N	N		S	S	S	S		X	X	X	X
1000	102	L	L	L	L	L		N	N	N	N		S	S	S	S		X	X	X	X	
1200	122	L	L	L	L			N	N	N	N		S	S	S	S		X	X	X	X	
1500	152	L	L	L	L			N	N	N	N		S	S	S	S		X	X	X	X	
1800	182	L	L	L	L			N	N	N	N		S	S	S	S		X	X	X	X	
2200	222	L	L	L	L			N	N	N	N		S	S	S	S		X	X	X	X	
2700	272	L	L	L	L			N	N	N	N		S	S	S	S		X	X	X	X	
3300	332	L	L	L	L			N	N	N	N		S	S	S	S		X	X	X	X	
3900	392	L	L	L	L			N	N	N	N		S	S	S	S		X	X	X	X	
4700	472	L	L	L	L			N	N	N	N		S	S	S	S		X	X	X	X	
5600	562	L	L	L	L			N	N	N	N		S	S	S	S		X	X	X	X	
6800	682	L	L	L				N	N	N	N		S	S	S	S		X	X	X	X	
8200	822	L	L	L				N	N	N	N		S	S	S	S		X	X	X	X	
10000	103	L	L	L	L			N	N	N	N		S	S	S	S		X	X	X	X	
12000	123							N	N	N	N/K		S	S	S	S		X	X	X	X	
15000	153							N	N	N	N/K		S	S	S	S		X	X	X	X	
18000	183							N	N	N	N/K		S	S	S	S		X	X	X	X	
22000	223		L	L				N	N	N	N/K		S	S	S	S		X	X	X	X	
27000	273							N	N	N	N/K		S	S	S	S		X	X	X	X	
33000	333							N	N	N	N/K		S	S	B	B		X	X	X	X	
39000	393							N	N	N	N/K		S	S	B	B		X	X	X	X	
47000	473							N	N	N	N/K		S	S	B	B		X	X	X	X	
56000	563							N	N	N	K		S	S	B	B		X	X	X	X	
68000	683							N	N	N	K		S	S	B	B		X	X	X	X	
82000	823							N	N	N	K		S	S	B	B		X	X	X	X/C	
100000	104							N	N	N	K		S	S	B	B		X	X	X	X/C	
120000	124												S	S	B			X	X	X	C	
150000	154												S	S	B	B		C	C	C	C	
180000	184												S	S	B			C	C	C	C	
220000	224							N	N	N	N			S	S	B	B		C	C	C	C/I
270000	274												B	B	B	B		C	C	C	I	
330000	334													B	B	B	B		C	C	C	I
390000	394													B	B	B			C	C	C	I
470000	474							N	N					B	B	B	B		C	C	C	I
560000	564													B	B				C	C	C	I
680000	684													B	B	B			C	C	C	I
820000	824													B	B				C	C	C	I

7. CAPACITANCE RANGE(Con.)

7-2. X7R

Cap(pF)	EIA Size Code	1206					1210					1812				1825		2220		2225	
		6.3V	10V	16V	25V	50V	6.3V	10V	16V	25V	50V	10V	16V	25V	50V	25V	50V	25V	50V	25V	50V
100	101				X	X															
120	121				X	X															
150	151		X	X	X	X															
180	181		X	X	X	X															
220	221		X	X	X	X				M	M										
270	271		X	X	X	X				M	M			C	C						
330	331		X	X	X	X				M	M			C	C						
390	391		X	X	X	X				M	M			C	C						
470	471		X	X	X	X				M	M			C	C						
560	561		X	X	X	X				M	M			C	C						
680	681		X	X	X	X				M	M			C	C						
820	821		X	X	X	X				M	M			C	C						
1000	102		X	X	X	X		M	M	M	M	C	C	C	C	F	F	F	F	F	F
1200	122		X	X	X	X		M	M	M	M	C	C	C	C	F	F	F	F	F	F
1500	152		X	X	X	X		M	M	M	M	C	C	C	C	F	F	F	F	F	F
1800	182		X	X	X	X		M	M	M	M	C	C	C	C	F	F	F	F	F	F
2200	222		X	X	X	X		M	M	M	M	C	C	C	C	F	F	F	F	F	F
2700	272		X	X	X	X		M	M	M	M	C	C	C	C	F	F	F	F	F	F
3300	332		X	X	X	X		M	M	M	M	C	C	C	C	F	F	F	F	F	F
3900	392		X	X	X	X		M	M	M	M	C	C	C	C	F	F	F	F	F	F
4700	472		X	X	X	X		M	M	M	M	C	C	C	C	F	F	F	F	F	F
5600	562		X	X	X	X		M	M	M	M	C	C	C	C	F	F	F	F	F	F
6800	682		X	X	X	X		M	M	M	M	C	C	C	C	F	F	F	F	F	F
8200	822		X	X	X	X		M	M	M	M	C	C	C	C	F	F	F	F	F	F
10000	103		X	X	X	X		M	M	M	M	C	C	C	C	F	F	F	F	F	F
12000	123		X	X	X	X		M	M	M	M	C	C	C	C	F	F	F	F	F	F
15000	153		X	X	X	X		M	M	M	M	C	C	C	C	F	F	F	F	F	F
18000	183		X	X	X	X		M	M	M	M	C	C	C	C	F	F	F	F	F	F
22000	223		X	X	X	X		M	M	M	M	C	C	C	C	F	F	F	F	F	F
27000	273		X	X	X	X		M	M	M	M	C	C	C	C	F	F	F	F	F	F
33000	333		X	X	X	X		M	M	M	M	C	C	C	C	F	F	F	F	F	F
39000	393		X	X	X	X		M	M	M	M	C	C	C	C	F	F	F	F	F	F
47000	473		X	X	X	X		M	M	M	M	C	C	C	C	F	F	F	F	F	F
56000	563		X	X	X	X		M	M	M	M	C	C	C	C	F	F	F	F	F	F
68000	683		X	X	X	X		M	M	M	M	C	C	C	C	F	F	F	F	F	F
82000	823		X	X	X	X		M	M	M	M	C	C	C	C	F	F	F	F	F	F
100000	104		X	X	X	X		M	M	M	M	C	C	C	C	F	F	F	F	F	F
120000	124		X	X	X	X		M	M	M	M	C	C	C	C	F	F	F	F	F	F
150000	154		M	M	M	M		M	M	M	M	C	C	C	C	F	F	F	F	F	F
180000	184		M	M	M	M		M	M	M	M	C	C	C	C	F	F	F	F	F	F
220000	224		M	M	M	M		M	M	M	M	C	C	C	C	F	F	F	F	F	F
270000	274		M	M	M	C		M	M	M	M	C	C	C	C	F	F	F	F	F	F
330000	334		M	M	M	C		M	M	M	C	C	C	C	C	F	F	F	F	F	F
390000	394		M	M	C	P		M	M	M	C	C	C	C	C	F	F	F	F	F	F
470000	474		J	J	C/J	P		M	M	M	C	C	C	C	C	F	F	F	F	F	F
560000	564		J	J	C/J	P		C	C	C	C	C	C	C	C	F	F	F	F	F	F
680000	684		J	J	C/J	P		C	C	C	C	C	C	C	F	F	F	F	F	F	F
820000	824		J	J	C/J	P		C	C	C	C	C	C	C	F	F	F	F	F	F	F



7. CAPACITANCE RANGE(Con.)

7-3. X5R

Cap(pF)	EIA Size	0201						0402						0603						
		Code	4V	6.3V	10V	16V	25V	50V	4V	6.3V	10V	16V	25V	50V	4V	6.3V	10V	16V	25V	50V
100	101				L	L	L													
120	121																			
150	151				L	L	L													
180	181																			
220	221				L	L	L													
270	271																			
330	331				L	L	L													
390	391																			
470	471				L	L	L													
560	561																			
680	681				L	L	L													
820	821																			
1000	102			L	L	L	L													
1500	152			L	L	L	L													
2200	222			L	L	L														
2700	272																			
3300	332			L	L															
4700	472			L	L															
6800	682			L	L															
10000	103		L	L	L	L	L													
15000	153		L	L																
22000	223		L	L									N	N						
27000	273																			
33000	333		L	L									N		N					
39000	393																			
47000	473		L	L					N	N	N			N						
56000	563		L	L																
68000	683		L	L					N	N	N			K						
82000	823																			
100000	104		L	L	L	L			N	N	N	N	K							S
150000	154								N	N	N	N								
220000	224								N	N	N	N	N		B	B	B	B	B	
270000	274																			
330000	334		L						N	N	N				B	B	B	B		
390000	394																			
470000	474	L	L						N	N	N/K	K	K		B	B	B	B	B	
680000	684								N	N					B	B	B	B		
820000	824																			

**7. CAPACITANCE RANGE(Con.)**

**7-5. X6S**

Cap(pF)	EIA Size	0201					0402				
	Code	4V	6.3V	10V	16V	25V	6.3V	10V	16V	25V	50V
100000	104	L	L	L	L	L	N				
150000	154										
220000	224		L	L*			N				
330000	334										
470000	474	L					K/N				
680000	684										

**7. CAPACITANCE RANGE(Con.)**

**7-6. X7S**

Cap(pF)	EIA Size	0201
	Code	10V
100000	104	L
150000	154	
220000	224	
330000	334	
470000	474	
680000	684	



**7. CAPACITANCE RANGE(Con.)**

**7-7. 01R5**

SIZE		01R5		
DIELECTRIC		NP0		
RATED VOLTAGE (VDC)		16	25	50
Capacitance	0.2pF (0R2)	✓	✓	✓
	0.3pF (0R3)	✓	✓	✓
	0.4pF (0R4)	✓	✓	✓
	0.5pF (0R5)	✓	✓	✓
	1.0pF (1R0)	✓	✓	✓
	1.5pF (1R5)	✓	✓	✓
	2.0pF (2R0)	✓	✓	✓
	3.0pF (3R0)	✓	✓	✓
	4.0pF (4R0)	✓	✓	✓
	5.0pF (5R0)	✓	✓	✓
	6.0pF (6R0)	✓	✓	✓
	7.0pF (7R0)	✓	✓	✓
	8.0pF (8R0)	✓	✓	✓
	9.0pF (9R0)	✓	✓	✓
	10pF (100)	✓	✓	✓
	12pF (120)	✓	✓	✓
	15pF (150)	✓	✓	✓
	18pF (180)	✓	✓	✓
	22pF (220)	✓	✓	✓
	27pF (270)	✓	✓	✓
	33pF (330)	✓	✓	✓
	39pF (390)	✓	✓	✓
47pF (470)	✓	✓	✓	
56pF (560)	✓	✓	✓	
68pF (680)	✓	✓	✓	
82pF (820)	✓	✓	✓	
100pF (101)	✓	✓	✓	
120pF (121)	✓	✓	✓	
150pF (151)	✓	✓	✓	
180pF (181)	✓	✓	✓	
220pF (221)	✓	✓	✓	

SIZE		01R5	
DIELECTRIC		X7R	
RATED VOLTAGE (VDC)		10	
Capacitance	100pF (101)	✓	
	150pF (151)	✓	
	220pF (221)	✓	
	330pF (331)	✓	
	470pF (471)	✓	
	1,000pF (102)	✓	

SIZE		01R5	
DIELECTRIC		X5R	
RATED VOLTAGE (VDC)		6.3	10
Capacitance	1,000pF (102)	✓	✓
	1,500pF (152)		✓
	2,200pF (222)		✓
	3,300pF (332)		✓
	4,700pF (472)		✓
	6,800pF (682)		✓
	0.010μF (103)	✓	✓
	0.015μF (153)		
	0.022μF (223)	✓	
	0.033μF (333)	✓	
	0.047μF (473)	✓	
	0.068μF (683)		
0.10μF (104)	✓		

**8. RELIABILITY TEST CONDITIONS AND REQUIREMENTS**

No.	Item	Test Condition	Requirements																																								
1.	Visual and Dimensions	---	* No remarkable defect. * Dimensions to confirm to individual specification sheet.																																								
2.	Capacitance		* Shall not exceed the limits given in the detailed spec.  * C0G : Cap.≥30pF, Q≥1000; Cap.<30pF, Q≥400+20C. * 01R5 : X7R: ≤5.0 % X5R: ≤10 %  * X7R/X5R/X7S/X6S :																																								
3.	Q/D.F. (Tangent of loss angle)	<p>* Class I : (C0G) Cap.≤1000pF, 1.0±0.2Vrms, 1MHz±10%. Cap.&gt;1000pF, 1.0±0.2Vrms, 1KHz±10%.</p> <p>* Class II : (X7R, X5R, X7S,X6S) Cap.≤10μF, 1.0±0.2Vrms, 1KHz±10%**. Cap.&gt;10μF, 0.5±0.2Vrms, 120Hz±20%.</p> <p>** Test condition : 0.5±0.2Vrms, 1KHz±10%. X5R : 0201≥224(6.3V,10V,16V)<sup>#1</sup>, X7R &amp; X5R(≥10V) &amp; 01R5X103≤6.3V &amp; 01R5X104≤10V * 0.5±0.2Vrms, 1kHz±10%: X5R(≤6.3V); Excluding 01R5X103≤6.3V &amp; 01R5X104≤10V</p>	<table border="1"> <thead> <tr> <th>Rated</th> <th>D.F.≤</th> <th colspan="2">Exception of D.F.≤</th> </tr> </thead> <tbody> <tr> <td rowspan="3">50V</td> <td rowspan="3">≤2.5%</td> <td>≤3.5%</td> <td>0201(50V), 0603≥0.047μF, 0805≥0.1μF, 1206≥0.47μF</td> </tr> <tr> <td>≤5%</td> <td>0201≥0.01uF</td> </tr> <tr> <td>≤10%</td> <td>0402≥0.012μF, 0603&gt;0.1μF</td> </tr> <tr> <td rowspan="3">25V</td> <td rowspan="3">≤3.5%</td> <td>≤5%</td> <td>0201≥0.01μF</td> </tr> <tr> <td>≤7%</td> <td>0603≥0.33μF</td> </tr> <tr> <td>≤10%</td> <td>0201≥0.1μF, 0402≥0.10μF, 0603≥0.47μF,</td> </tr> <tr> <td rowspan="3">16V</td> <td rowspan="3">≤3.5%</td> <td>≤5%</td> <td>0201≥0.01μF, 0402≥0.033μF, 0603≥0.15μF, 0805≥0.68μF</td> </tr> <tr> <td>≤10%</td> <td>0201≥0.1uF(0201/X7R≥0.022μF), 0402≥0.22uF, 0603≥0.68μF</td> </tr> <tr> <td>≤15%</td> <td>0201≥0.012μF, 0402≥0.33μF(0402/X7R≥0.22μF), 0603≥0.33μF</td> </tr> <tr> <td>10V</td> <td>≤5%</td> <td>≤10%</td> <td>0201≥0.1μF</td> </tr> <tr> <td>6.3V</td> <td>≤10%</td> <td>≤15%</td> <td>0201≥0.1μF</td> </tr> <tr> <td>4V</td> <td>≤15%</td> <td>---</td> <td>---</td> </tr> </tbody> </table>	Rated	D.F.≤	Exception of D.F.≤		50V	≤2.5%	≤3.5%	0201(50V), 0603≥0.047μF, 0805≥0.1μF, 1206≥0.47μF	≤5%	0201≥0.01uF	≤10%	0402≥0.012μF, 0603>0.1μF	25V	≤3.5%	≤5%	0201≥0.01μF	≤7%	0603≥0.33μF	≤10%	0201≥0.1μF, 0402≥0.10μF, 0603≥0.47μF,	16V	≤3.5%	≤5%	0201≥0.01μF, 0402≥0.033μF, 0603≥0.15μF, 0805≥0.68μF	≤10%	0201≥0.1uF(0201/X7R≥0.022μF), 0402≥0.22uF, 0603≥0.68μF	≤15%	0201≥0.012μF, 0402≥0.33μF(0402/X7R≥0.22μF), 0603≥0.33μF	10V	≤5%	≤10%	0201≥0.1μF	6.3V	≤10%	≤15%	0201≥0.1μF	4V	≤15%	---	---
Rated	D.F.≤	Exception of D.F.≤																																									
50V	≤2.5%	≤3.5%	0201(50V), 0603≥0.047μF, 0805≥0.1μF, 1206≥0.47μF																																								
		≤5%	0201≥0.01uF																																								
		≤10%	0402≥0.012μF, 0603>0.1μF																																								
25V	≤3.5%	≤5%	0201≥0.01μF																																								
		≤7%	0603≥0.33μF																																								
		≤10%	0201≥0.1μF, 0402≥0.10μF, 0603≥0.47μF,																																								
16V	≤3.5%	≤5%	0201≥0.01μF, 0402≥0.033μF, 0603≥0.15μF, 0805≥0.68μF																																								
		≤10%	0201≥0.1uF(0201/X7R≥0.022μF), 0402≥0.22uF, 0603≥0.68μF																																								
		≤15%	0201≥0.012μF, 0402≥0.33μF(0402/X7R≥0.22μF), 0603≥0.33μF																																								
10V	≤5%	≤10%	0201≥0.1μF																																								
6.3V	≤10%	≤15%	0201≥0.1μF																																								
4V	≤15%	---	---																																								

8. RELIABILITY TEST CONDITIONS AND REQUIREMENTS

No.	Item	Test Condition	Requirements																																								
4.	Temperature Coefficient (Temperature characteristic of capacitance)	<p>* With no electrical load.</p> <table border="1"> <thead> <tr> <th>T.C.</th> <th>Operating Temp.</th> </tr> </thead> <tbody> <tr> <td>C0G</td> <td>-55~125°C at 25°C</td> </tr> <tr> <td>X7R</td> <td>-55~125°C at 25°C</td> </tr> <tr> <td>X5R</td> <td>-55~ 85°C at 25°C</td> </tr> <tr> <td>X7S</td> <td>-55 ~ 125°C at 25°C</td> </tr> <tr> <td>X6S</td> <td>-55~105°C at 25°C</td> </tr> </tbody> </table> <p>* Measurement voltage for Class II :</p> <table border="1"> <thead> <tr> <th>Size</th> <th>Cap. Range</th> <th>Condition</th> </tr> </thead> <tbody> <tr> <td rowspan="2">0201</td> <td>Cap.&lt;0.1μF</td> <td>1V</td> </tr> <tr> <td>0.1μF≤Cap.&lt;1μF</td> <td>0.2V</td> </tr> <tr> <td>0402</td> <td>Cap.&lt;0.1μF</td> <td>1V</td> </tr> <tr> <td rowspan="2">01R5</td> <td>Cap≤0.01μF</td> <td>0.5V</td> </tr> <tr> <td>Cap&gt;0.01μF</td> <td>0.2V</td> </tr> </tbody> </table>	T.C.	Operating Temp.	C0G	-55~125°C at 25°C	X7R	-55~125°C at 25°C	X5R	-55~ 85°C at 25°C	X7S	-55 ~ 125°C at 25°C	X6S	-55~105°C at 25°C	Size	Cap. Range	Condition	0201	Cap.<0.1μF	1V	0.1μF≤Cap.<1μF	0.2V	0402	Cap.<0.1μF	1V	01R5	Cap≤0.01μF	0.5V	Cap>0.01μF	0.2V	<table border="1"> <thead> <tr> <th>T.C.</th> <th>Capacitance Change</th> </tr> </thead> <tbody> <tr> <td>C0G</td> <td>Within ±30ppm/°C</td> </tr> <tr> <td>X7R</td> <td>Within ±15%</td> </tr> <tr> <td>X5R</td> <td>Within ±15%</td> </tr> <tr> <td>X7S</td> <td>Within ±22%</td> </tr> <tr> <td>X6S</td> <td>Within ±22%</td> </tr> </tbody> </table>	T.C.	Capacitance Change	C0G	Within ±30ppm/°C	X7R	Within ±15%	X5R	Within ±15%	X7S	Within ±22%	X6S	Within ±22%
		T.C.	Operating Temp.																																								
C0G	-55~125°C at 25°C																																										
X7R	-55~125°C at 25°C																																										
X5R	-55~ 85°C at 25°C																																										
X7S	-55 ~ 125°C at 25°C																																										
X6S	-55~105°C at 25°C																																										
Size	Cap. Range	Condition																																									
0201	Cap.<0.1μF	1V																																									
	0.1μF≤Cap.<1μF	0.2V																																									
0402	Cap.<0.1μF	1V																																									
01R5	Cap≤0.01μF	0.5V																																									
	Cap>0.01μF	0.2V																																									
T.C.	Capacitance Change																																										
C0G	Within ±30ppm/°C																																										
X7R	Within ±15%																																										
X5R	Within ±15%																																										
X7S	Within ±22%																																										
X6S	Within ±22%																																										
5.	Insulation Resistance	<p>* To apply rated voltage for Max. 120sec.</p>	<p>* ≥10GΩ or RxC≥500Ω-F, whichever is smaller. 01R5: NP0, X7R: ≥10GΩ or RxC≥500Ω-F whichever is smaller. X5R: RxC≥50Ω-F</p> <p>* Except :</p> <table border="1"> <thead> <tr> <th>Rated voltage (X7R/X5R/ X7S/X6S)</th> <th>I.R.</th> </tr> </thead> <tbody> <tr> <td>50V : 0402&gt;0.01μF</td> <td rowspan="4">≥10GΩ or RxC≥100Ω-F, whichever is smaller</td> </tr> <tr> <td>16V : 0201≥0.1μF, 0402≥0.22μF</td> </tr> <tr> <td>10V : 0201≥47nF, 0402≥0.47μF, 0603≥0.47μF, 6.3V; 4V</td> </tr> <tr> <td>Rated voltage (X7R/X5R/ X7S/X6S)</td> </tr> <tr> <td>50V : 0402≥0.1μF</td> <td rowspan="4">RxC≥50Ω-F</td> </tr> <tr> <td>25V : 0201≥0.1μF</td> </tr> <tr> <td>16V : 0603≥10μF, 0402≥1μF, 0201≥0.22μF</td> </tr> <tr> <td>10V : 0201&gt;0.1μF</td> </tr> <tr> <td>6.3V : 0201≥0.1μF</td> <td></td> </tr> </tbody> </table>	Rated voltage (X7R/X5R/ X7S/X6S)	I.R.	50V : 0402>0.01μF	≥10GΩ or RxC≥100Ω-F, whichever is smaller	16V : 0201≥0.1μF, 0402≥0.22μF	10V : 0201≥47nF, 0402≥0.47μF, 0603≥0.47μF, 6.3V; 4V	Rated voltage (X7R/X5R/ X7S/X6S)	50V : 0402≥0.1μF	RxC≥50Ω-F	25V : 0201≥0.1μF	16V : 0603≥10μF, 0402≥1μF, 0201≥0.22μF	10V : 0201>0.1μF	6.3V : 0201≥0.1μF																											
Rated voltage (X7R/X5R/ X7S/X6S)	I.R.																																										
50V : 0402>0.01μF	≥10GΩ or RxC≥100Ω-F, whichever is smaller																																										
16V : 0201≥0.1μF, 0402≥0.22μF																																											
10V : 0201≥47nF, 0402≥0.47μF, 0603≥0.47μF, 6.3V; 4V																																											
Rated voltage (X7R/X5R/ X7S/X6S)																																											
50V : 0402≥0.1μF	RxC≥50Ω-F																																										
25V : 0201≥0.1μF																																											
16V : 0603≥10μF, 0402≥1μF, 0201≥0.22μF																																											
10V : 0201>0.1μF																																											
6.3V : 0201≥0.1μF																																											

### 8. RELIABILITY TEST CONDITIONS AND REQUIREMENTS

No.	Item	Test Condition	Requirements															
6.	<b>Dielectric Strength</b>	<ul style="list-style-type: none"> <li>* To apply 250% of rated voltage.</li> <li>* Duration : 1 to 5 sec.</li> <li>* Charge and discharge current less than 50mA.</li> </ul>	<ul style="list-style-type: none"> <li>* No evidence of damage or flash over during test.</li> </ul>															
7.	<b>Solderability</b>	<ul style="list-style-type: none"> <li>* Solder temperature : 235±5°C for (01R5,0201~1210).</li> <li>* Solder temperature : 245±5°C for (1808~2225).</li> <li>* Dipping time : 2±0.5 sec.</li> </ul>	<ul style="list-style-type: none"> <li>* 75% min. coverage of all metalized area.</li> <li>* 95% min. coverage of all metalized area.(for 01R5)</li> </ul>															
8.	<b>Resistance to Soldering Heat</b>	<ul style="list-style-type: none"> <li>* Solder temperature : 260±5°C.</li> <li>* Dipping time : 10±1 sec.</li> <li>* Preheating : 120 to 150°C for 1 minute before immerse the capacitor in a eutectic solder.</li> <li>* Before initial measurement (Class II only) : To apply de-aging at 150°C for 1hr then set for 24±2 hrs at room temp.</li> <li>* Measurement to be made after keeping at room temp. for 24±2 hrs (Class I) or 48±4 hrs (Class II).</li> </ul>	<ul style="list-style-type: none"> <li>* No remarkable damage.</li> <li>* Cap. change : C0G : Within ±2.5% or ±0.25pF, whichever is larger. X7R, X5R,X6S,X7S : Within ±7.5%.</li> <li>* D.F.(Q)/I.R. : To meet initial requirements.</li> <li>* 25% max. leaching on each edge.</li> </ul>															
9.	<b>Temperature Cycle (Rapid change of temperature)</b>	<ul style="list-style-type: none"> <li>* Conduct the five cycles according to the temperatures and time.</li> </ul> <table border="1"> <thead> <tr> <th>Step</th> <th>Temp.(°C)</th> <th>Time(min.)</th> </tr> </thead> <tbody> <tr> <td>1</td> <td>Min. operating temp. +0/-3</td> <td>30±3</td> </tr> <tr> <td>2</td> <td>Room temp.</td> <td>2~3</td> </tr> <tr> <td>3</td> <td>Max. operating temp. +3/-0</td> <td>30±3</td> </tr> <tr> <td>4</td> <td>Room temp.</td> <td>2~3</td> </tr> </tbody> </table> <ul style="list-style-type: none"> <li>* Before initial measurement (Class II only) : To apply de-aging at 150°C for 1hr then set for 24±2 hrs at room temp.</li> <li>* Measurement to be made after keeping at room temp. for 24±2 hrs (Class I) or 48±4 hrs (Class II).</li> </ul>	Step	Temp.(°C)	Time(min.)	1	Min. operating temp. +0/-3	30±3	2	Room temp.	2~3	3	Max. operating temp. +3/-0	30±3	4	Room temp.	2~3	<ul style="list-style-type: none"> <li>* No remarkable damage.</li> <li>* Cap. change : C0G : Within ±2.5% or ±0.25pF, whichever is larger. X7R, X5R ,X7S, X6S : Within ±7.5%.</li> <li>01R5 X5R: Within ±15.0%</li> <li>* Q for C0G : To meet initial requirements.</li> <li>* D.F.(Class II) : ≤150% of initial requirement.</li> <li>* I.R. : To meet initial requirements.</li> <li>* 01R5 Q/D.F., I.R. and dielectric strength: To meet initial requirements.</li> </ul>
Step	Temp.(°C)	Time(min.)																
1	Min. operating temp. +0/-3	30±3																
2	Room temp.	2~3																
3	Max. operating temp. +3/-0	30±3																
4	Room temp.	2~3																



8. RELIABILITY TEST CONDITIONS AND REQUIREMENTS

No.	Item	Test Condition	Requirements					
10.	Humidity (Damp Heat) Steady State	* Test temp. : 40±2°C. * Humidity : 90~95% RH. * Test time : 500 +24/-0hrs. * Before initial measurement (Class II only) : To apply de-aging at 150°C for 1hr then set for 24±2 hrs at room temp. * Measurement to be made after keeping at room temp. for 24±2 hrs (Class I) or 48±4 hrs (Class II).	* No remarkable damage. * Cap. change : C0G : Within ±5.0% or ±0.5pF, whichever is larger. X7R, X5R, X6S, X7S : Within ±12.5% for ≥10V**, within ±25% for 6.3V. 01R5 X5R: within ±25.0% **10V : Within ±25% for 0603≥4.7μF, 0402≥1μF, 0201≥0.1μF. * Q/DF for C0G : Cap.>30pF, Q≥350. 10pF≤Cap.≤30pF, Q≥275+2.5C. Cap.<10pF, Q≥200+10C. 01R5 X7R : ≤7.5% 01R5 X5R: ≤20% *I.R 01R5 : NP0, X7R: ≥1GΩ or RxC≥50Ω-F whichever is smaller. X5R: RxC≥10Ω-F. * D.F.(Class II) : ≤200% of initial requirement. * I.R. : ≥10V, ≥1GΩ or RxC≥50Ω-F, whichever is smaller. Class II (X7R, X5R, X7S, X6S )					
			<table border="1"> <thead> <tr> <th>Rated voltage</th> <th>I.R.</th> </tr> </thead> <tbody> <tr> <td>50V : 0402&gt;0.01μF</td> <td rowspan="5">≥1GΩ or RxC≥10Ω-F, whichever is smaller</td> </tr> <tr> <td>25V : 0201≥0.1uF, 0402≥0.22μF</td> </tr> <tr> <td>16V : 0201≥0.1uF, 0402≥0.22μF</td> </tr> <tr> <td>10V : 0201≥47nF, 0402≥0.47μF, 0603≥0.47μF,</td> </tr> <tr> <td>6.3V; 4V; Size≥1812</td> </tr> </tbody> </table>	Rated voltage	I.R.	50V : 0402>0.01μF	≥1GΩ or RxC≥10Ω-F, whichever is smaller	25V : 0201≥0.1uF, 0402≥0.22μF
Rated voltage	I.R.							
50V : 0402>0.01μF	≥1GΩ or RxC≥10Ω-F, whichever is smaller							
25V : 0201≥0.1uF, 0402≥0.22μF								
16V : 0201≥0.1uF, 0402≥0.22μF								
10V : 0201≥47nF, 0402≥0.47μF, 0603≥0.47μF,								
6.3V; 4V; Size≥1812								
11.	Humidity (Damp Heat) Load	* Test temp. : 40±2°C. * Humidity : 90~95%RH. * Test time : 500 +24/-0hrs. * To apply voltage : Rated voltage. * Before initial measurement (Class II only) : To apply de-aging at 150°C for 1hr then set for 24±2 hrs at room temp. * Measurement to be made after keeping at room temp. for 24±2 hrs (Class I) or 48±4 hrs (Class II).	* No remarkable damage. * Cap. change : C0G : Within ±7.5% or ±0.75pF, whichever is larger. X7R, X5R, X7S, X6S : Within ±12.5% for ≥10V**, within ±25% for 6.3V. **10V : Within ±25% for 0603≥4.7μF, 0402≥1μF, 0201≥0.1μF. * Q for C0G : Cap.≥30pF, Q≥200; Cap.<30pF, Q≥100+10/3C. * 01R5 Q/D.F. value: NP0: Cap≥30pF, Q≥200; Cap<30pF; Q≥100+10/3C X7R: ≤7.5% X5R: ≤20% * I.R.: NP0, X7R: ≥500MΩ or RxC≥25Ω-F whichever is smaller. X5R: RxC≥5Ω-F. * D.F.(Class II) : ≤200% of initial requirement. * I.R. : ≥10V, ≥500MΩ or RxC≥25Ω-F, whichever is smaller. Class II (X7R, X5R, X7S, X6S)					
			<table border="1"> <thead> <tr> <th>Rated voltage</th> <th>I.R.</th> </tr> </thead> <tbody> <tr> <td>50V : 0402&gt;0.01μF</td> <td rowspan="5">≥500MΩ or RxC≥5Ω-F, whichever is smaller</td> </tr> <tr> <td>25V : 0201≥0.1uF, 0402≥0.22μF</td> </tr> <tr> <td>16V : 0201≥0.1uF, 0402≥0.22μF</td> </tr> <tr> <td>10V : 0201≥47nF, 0402≥0.47μF, 0603≥0.47μF,</td> </tr> <tr> <td>6.3V; 4V; Size≥1812</td> </tr> </tbody> </table>	Rated voltage	I.R.	50V : 0402>0.01μF	≥500MΩ or RxC≥5Ω-F, whichever is smaller	25V : 0201≥0.1uF, 0402≥0.22μF
Rated voltage	I.R.							
50V : 0402>0.01μF	≥500MΩ or RxC≥5Ω-F, whichever is smaller							
25V : 0201≥0.1uF, 0402≥0.22μF								
16V : 0201≥0.1uF, 0402≥0.22μF								
10V : 0201≥47nF, 0402≥0.47μF, 0603≥0.47μF,								
6.3V; 4V; Size≥1812								

8. RELIABILITY TEST CONDITIONS AND REQUIREMENTS

No.	Item	Test Condition	Requirements																																																			
12.	High Temperature Load (Endurance)	<p>* Test temp. : C0G, X7R,X7S : 125±3°C. X5R : 85±3°C. X6S: 105±3°C</p> <p>* To apply voltage : (1) ≤6.3V : 150% of rated voltage. (2) 10V≤Ur≤50V : 200% of rated voltage. (3) 100% of rated voltage for below range :</p> <table border="1"> <thead> <tr> <th>Size</th> <th>Dielectric</th> <th>Rated</th> <th>Capacitance range</th> </tr> </thead> <tbody> <tr> <td rowspan="2">0201</td> <td rowspan="2">X5R/X7R</td> <td>≤10V</td> <td>C≥0.1μF</td> </tr> <tr> <td>≥16V</td> <td>C&gt;0.1μF</td> </tr> <tr> <td>01R5</td> <td>X5R</td> <td>6.3V</td> <td>-</td> </tr> </tbody> </table> <p>(4) 150% of rated voltage for below range :</p> <table border="1"> <thead> <tr> <th>Size</th> <th>Dielectric</th> <th>Rated Voltage</th> <th>Capacitance</th> </tr> </thead> <tbody> <tr> <td>01R5</td> <td>X5R</td> <td>10V</td> <td>-</td> </tr> <tr> <td rowspan="2">0201</td> <td rowspan="2">X5R/X7R/X6S</td> <td>16V/25V</td> <td>C≥0.1μF</td> </tr> <tr> <td>X7R</td> <td>16V</td> <td>C≥0.022μF</td> </tr> <tr> <td rowspan="2">0402</td> <td rowspan="2">X5R/X7R/X6S</td> <td>50V</td> <td>C≥0.1μF</td> </tr> <tr> <td>10~25V</td> <td>C≥0.22μF</td> </tr> <tr> <td>0603</td> <td>X7R</td> <td>≥50V</td> <td>C≥0.082μF</td> </tr> <tr> <td>0805</td> <td>X5R/X7R</td> <td>50V</td> <td>C≥0.47μF</td> </tr> </tbody> </table> <p>* Test time : 1000 +24/-0 hrs. * Before initial measurement (Class II only) : To apply de-aging at 150°C for 1hr then set for 24±2 hrs at room temp. * Measurement to be made after keeping at room temp. for 24±2 hrs (Class I) or 48±4 hrs (Class II). ** De-rating conditions : (For 100% of rated voltage items)</p>	Size	Dielectric	Rated	Capacitance range	0201	X5R/X7R	≤10V	C≥0.1μF	≥16V	C>0.1μF	01R5	X5R	6.3V	-	Size	Dielectric	Rated Voltage	Capacitance	01R5	X5R	10V	-	0201	X5R/X7R/X6S	16V/25V	C≥0.1μF	X7R	16V	C≥0.022μF	0402	X5R/X7R/X6S	50V	C≥0.1μF	10~25V	C≥0.22μF	0603	X7R	≥50V	C≥0.082μF	0805	X5R/X7R	50V	C≥0.47μF	<p>* No remarkable damage.</p> <p>* Cap. change : C0G: Within ±3.0% or ±0.3pF, whichever is larger. X7R, X5R,X7S, X6S : Within ±12.5% for ≥10V**, within ±25% for ≤6.3V. 01R5 :X7R Within ±12.5%,X5R Within ±25.0% **10V : Within ±25% for 0603≥4.7μF, 0402≥1μF, 0201≥0.1μF.</p> <p>* Q for C0G : Cap.&gt;30pF, Q≥350. 10pF≤Cap.≤30pF, Q≥275+2.5C. 01R5 : X7R ≤7.5%, X5R ≤20% Cap.&lt;10pF, Q≥200+10C.</p> <p>* D.F.(Class II) : ≤200% of initial requirement.</p> <p>* I.R. : ≥10V, ≥1GΩ or RxC≥50Ω-F, whichever is smaller. *01R5 I.R.: NP0, X7R: ≥1GΩ or RxC≥50Ω-F whichever is smaller. X5R: RxC≥10Ω-F. Class II (X7R, X5R, X7S, X6S )</p> <table border="1"> <thead> <tr> <th>Rated voltage</th> <th>I.R.</th> </tr> </thead> <tbody> <tr> <td>50V : 0402&gt;0.01μF</td> <td rowspan="5">≥1GΩ or RxC≥10Ω-F, whichever is smaller</td> </tr> <tr> <td>25V : 0201≥0.1uF, 0402≥0.22μF</td> </tr> <tr> <td>16V : 0201≥0.1uF, 0402≥0.22μF</td> </tr> <tr> <td>10V : 0201≥47nF, 0402≥0.47μF, 0603≥0.47μF,</td> </tr> <tr> <td>6.3V; 4V; Size≥1812</td> </tr> </tbody> </table>	Rated voltage	I.R.	50V : 0402>0.01μF	≥1GΩ or RxC≥10Ω-F, whichever is smaller	25V : 0201≥0.1uF, 0402≥0.22μF	16V : 0201≥0.1uF, 0402≥0.22μF	10V : 0201≥47nF, 0402≥0.47μF, 0603≥0.47μF,	6.3V; 4V; Size≥1812
Size	Dielectric	Rated	Capacitance range																																																			
0201	X5R/X7R	≤10V	C≥0.1μF																																																			
		≥16V	C>0.1μF																																																			
01R5	X5R	6.3V	-																																																			
Size	Dielectric	Rated Voltage	Capacitance																																																			
01R5	X5R	10V	-																																																			
0201	X5R/X7R/X6S	16V/25V	C≥0.1μF																																																			
		X7R	16V	C≥0.022μF																																																		
0402	X5R/X7R/X6S	50V	C≥0.1μF																																																			
		10~25V	C≥0.22μF																																																			
0603	X7R	≥50V	C≥0.082μF																																																			
0805	X5R/X7R	50V	C≥0.47μF																																																			
Rated voltage	I.R.																																																					
50V : 0402>0.01μF	≥1GΩ or RxC≥10Ω-F, whichever is smaller																																																					
25V : 0201≥0.1uF, 0402≥0.22μF																																																						
16V : 0201≥0.1uF, 0402≥0.22μF																																																						
10V : 0201≥47nF, 0402≥0.47μF, 0603≥0.47μF,																																																						
6.3V; 4V; Size≥1812																																																						

8. RELIABILITY TEST CONDITIONS AND REQUIREMENTS

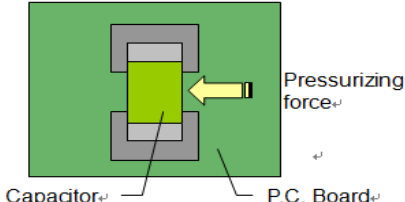
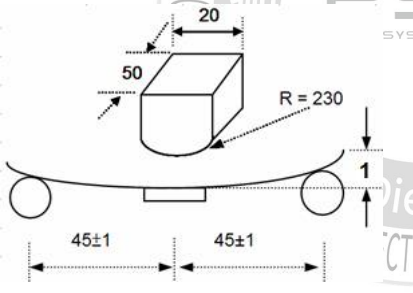
No.	Item	Test Condition	Requirements								
13.	Adhesive Strength of Termination (Robustness of termination)	<p>* Capacitors mounted on a substrate. A force of 1N(01R5) or 2N(0201) or 5N(0402~0603) or 10N(&gt;0603) applied perpendicular to the place of substrate and parallel the line joining the center of terminations for 10±1 second.</p>  <p>Capacitor, P.C. Board, Pressurizing force</p>	<p>* No remarkable damage or removal of the terminations.</p>								
14.	Resistance to Flexure of Substrate (Substrate bending test)	<p>* The middle part of substrate shall be pressurized by means of the pressurizing rod at a rate of about 1mm per second until the deflection becomes 1mm.</p>  <p>Unit : mm</p>	<p>* No remarkable damage.</p> <table border="1"> <thead> <tr> <th>Dielectric</th> <th>Cap. Change</th> </tr> </thead> <tbody> <tr> <td>C0G</td> <td>Within ±5.0% or ±0.5pF, whichever is larger</td> </tr> <tr> <td>X7R, X5R, X7S, X6S</td> <td>Within ±12.5%</td> </tr> <tr> <td>01R5 X5R</td> <td>Within ±25.0%</td> </tr> </tbody> </table> <p>(This capacitance change means the change of capacitance under specified flexure of substrate from the capacitance measured before the test)</p>	Dielectric	Cap. Change	C0G	Within ±5.0% or ±0.5pF, whichever is larger	X7R, X5R, X7S, X6S	Within ±12.5%	01R5 X5R	Within ±25.0%
Dielectric	Cap. Change										
C0G	Within ±5.0% or ±0.5pF, whichever is larger										
X7R, X5R, X7S, X6S	Within ±12.5%										
01R5 X5R	Within ±25.0%										
15.	Vibration Resistance	<p>* Vibration frequency : 10~55 Hz/min.                      * Total amplitude : 1.5mm.                      * Test time : 6 hrs. (Two hrs each in three mutually perpendicular directions)                      * Before initial measurement (Class II only) : To apply de-aging at 150°C for 1hr then set for 24±2 hrs at room temp.                      * Measurement to be made after keeping at room temp. for 24±2 hrs (Class I) or 48±4 hrs (Class II).</p>	<p>* No remarkable damage.                      * Cap. change and D.F. : To meet initial spec.</p>								

**9. PACKAGE DIMENSION AND QUANTITY**

Size	Thickness (mm)	Paper tape		Plastic tape	
		7" reel	13" reel	7" reel	13" reel
01R5 (0402)	0.20±0.02	20k	-	-	-
	0.30±0.03	15k	70k	-	-
0201(0603)	0.30±0.05	15k	-	-	-
	0.30±0.09	15k	-	-	-
0402(1005)	0.50±0.05	10k	50k	-	-
	0.50 +0.02/-0.05	10k	50k	-	-
	0.50±0.20	10k	-	-	-
0603(1608)	0.50±0.10	4k	-	-	-
	0.80±0.07	4k	15k	-	-
	0.80 +0.15/-0.10	4k	15k	-	-
0805(2012)	0.50±0.10	4k	15k	-	-
	0.60±0.10	4k	15k	-	-
	0.80±0.10	4k	15k	-	-
	0.85±0.10	4k	15k	-	-
	1.25±0.10	-	-	3k	10k
1206(3216)	1.25±0.20	-	-	3k	10k
	0.80±0.10	4k	15k	-	-
	0.85±0.10	4k	15k	-	-
	0.95±0.10	-	-	3k	10k
	1.15±0.15	-	-	3k	10k
	1.25±0.10	-	-	3k	10k
1210(3225)	1.60±0.20	-	-	2k	10k
	1.60 +0.30/-0.10	-	-	2k	9k
	0.85±0.10	-	-	3k	10k
	0.95±0.10	-	-	3k	10k
	1.25±0.10	-	-	3k	10k
	1.60±0.20	-	-	2k	-
1808(4520)	2.00±0.20	-	-	1k	6k
	2.50±0.30	-	-	1k	6k
	1.25±0.10	-	-	2k	10k
	1.60±0.20	-	-	2k	8k
	2.00±0.20	-	-	1k	6k
1812(4532)	1.25±0.10	-	-	1k	5k
	1.60±0.20	-	-	1k	-
	2.00±0.20	-	-	1k	-
	2.50±0.30	-	-	0.5k	3k
	2.80±0.30	-	-	0.5k	-
1825(4563)	1.60±0.20	-	-	1k	-
	2.00±0.20	-	-	1k	-
	2.50±0.30	-	-	0.5k	-
	2.80±0.30	-	-	0.5k	-
2220(5750)	1.60±0.20	-	-	1k	-
	2.00±0.20	-	-	1k	-
	2.50±0.30	-	-	0.5k	-
	2.80±0.30	-	-	0.5k	-
2225(5763)	1.60±0.20	-	-	1k	-
	2.00±0.20	-	-	1k	-
	2.50±0.30	-	-	0.5k	-
	2.80±0.30	-	-	0.5k	-

Unit : pcs

9. PACKAGE DIMENSION AND QUANTITY

9.1. EMBOSSED TAPE DIMENSIONS

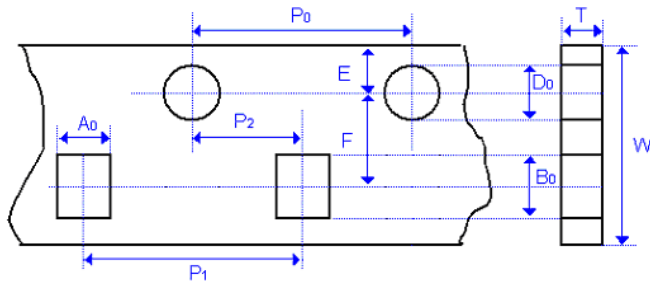

Fig. 9.1 The dimension of paper tape

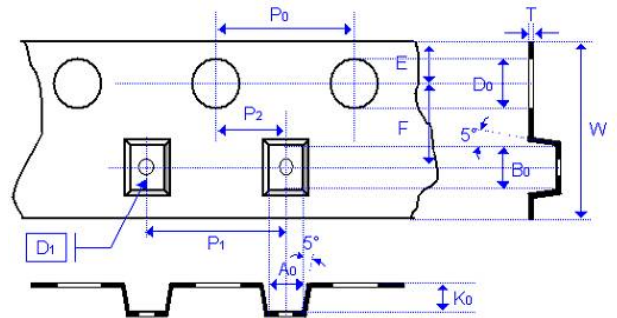

Fig. 9.2 The dimension of plastic tape

Size	01R5	0201	0402	0603
Chip Thickness	0.20±0.02	0.50±0.05 0.50±0.10	0.50±0.05 0.50±0.10	0.80±0.07 0.80 +0.15/-0.1
A <sub>0</sub>	0.25±0.05	0.40±0.10	0.70±0.20	1.05 ±0.30
B <sub>0</sub>	0.45±0.07	0.70±0.10	1.20±0.20	1.80±0.30
T	≤0.50	≤0.55	≤0.80	≤1.20
K <sub>0</sub>	-	-	-	-
W	8.00±0.30	8.00±0.30	8.00±0.30	8.00±0.30
P <sub>0</sub>	4.00±0.10	4.00±0.10	4.00±0.10	4.00±0.10
10xP <sub>0</sub>	40.00±0.10	40.00±0.10	40.00±0.10	40.00±0.20
P <sub>1</sub>	2.00±0.05	2.00±0.05	2.00±0.05	4.00±0.10
P <sub>2</sub>	2.00±0.05	2.00±0.05	2.00±0.05	2.00±0.05
D <sub>0</sub>	1.50+0.1/-0	1.50+0.1/-0	1.50+0.1/-0	1.50+0.1/-0
D <sub>1</sub>	-	-	-	-
E	1.75±0.10	1.75±0.10	1.75±0.10	1.75±0.10
F	3.50±0.05	3.50±0.05	3.50±0.05	3.50±0.05
Unit :	mm	mm	mm	mm

Size	0805		1206			1210	
Chip Thickness	0.80±0.10	1.25±0.10 1.25±0.20	0.80±0.10	0.95±0.10 1.25±0.10	1.60±0.20 1.60 +0.30/ -0.10	1.25±0.10 1.60±0.20	2.50±0.30
A <sub>0</sub>	1.50±0.20	<1.80	2.00±0.10	<2.00	<2.50	<3.05	<3.20
B <sub>0</sub>	2.30±0.20	<2.70	3.50±0.50	<3.70	<4.00	<3.80	<4.00
T	0.95±0.05	0.23±0.05	0.95±0.05	0.23±0.05	0.23±0.05	0.23±0.05	0.23±0.05
K <sub>0</sub>	-	<2.50	-	<2.50	<2.50	<2.50	<3.50
W	8.00±0.10	8.00±0.10	8.00±0.10	8.00±0.10	8.00±0.10	8.00±0.10	8.00±0.10
P <sub>0</sub>	4.00±0.10	4.00±0.10	4.00±0.10	4.00±0.10	4.00±0.10	4.00±0.10	4.00±0.10
10xP <sub>0</sub>	40.00±0.20	40.00±0.20	40.00±0.20	40.00±0.20	40.00±0.20	40.00±0.20	40.00±0.20
P <sub>1</sub>	4.00±0.10	4.00±0.10	4.00±0.10	4.00±0.10	4.00±0.10	4.00±0.10	4.00±0.10
P <sub>2</sub>	2.00±0.05	2.00±0.05	2.00±0.05	2.00±0.05	2.00±0.05	2.00±0.05	2.00±0.05
D <sub>0</sub>	1.50 +0.10/-0	1.50 +0.10/-0	1.50 +0.10/-0	1.50 +0.10/-0	1.50 +0.10/-0	1.50 +0.10/-0	1.50 +0.10/-0
D <sub>1</sub>	-	1.00±0.10	-	1.00±0.10	1.50±0.10	1.50±0.10	1.00±0.10
E	1.75±0.05	1.75±0.10	1.75±0.10	1.75±0.10	1.75±0.10	1.75±0.10	1.75±0.10
F	3.50±0.05	3.50±0.05	3.50±0.05	3.50±0.05	5.50±0.05	5.50±0.05	3.50±0.05
Unit :	mm	mm	mm	mm	mm	mm	mm



**9. PACKAGE DIMENSION AND QUANTITY**

Size	1808		1812		1825	
Chip Thickness	1.25±0.10 1.60±0.20	2.00±0.20	1.25±0.10 1.60±0.20 2.00±0.20	2.50±0.30 2.80±0.30	1.60±0.20 2.00±0.20	2.50±0.30 2.80±0.30
A <sub>0</sub>	<2.50	<2.50	<3.90	<3.90	<6.80	<6.80
B <sub>0</sub>	<5.30	<5.30	<5.30	<5.30	<5.30	<5.30
T	0.25±0.05	0.25±0.05	0.25±0.05	0.25±0.05	0.30±0.10	0.30±0.10
K <sub>0</sub>	<2.50	<2.50	<2.50	<3.00	<2.50	<3.10
W	12.00±0.20	12.00±0.20	12.00±0.20	12.00±0.20	12.00±0.20	12.00±0.20
P <sub>0</sub>	4.00±0.10	4.00±0.10	4.00±0.10	4.00±0.10	4.00±0.10	4.00±0.10
10xP <sub>0</sub>	40.00±0.20	40.00±0.20	40.00±0.20	40.00±0.20	40.00±0.20	40.00±0.20
P <sub>1</sub>	4.00±0.10	4.00±0.10	8.00±0.10	8.00±0.10	8.00±0.10	8.00±0.10
P <sub>2</sub>	2.00±0.05	2.00±0.05	2.00±0.05	2.00±0.05	2.00±0.05	2.00±0.05
D <sub>0</sub>	1.50 +0.10/-0	1.50 +0.10/-0	1.50 +0.10/-0	1.50 +0.10/-0	1.50 +0.10/-0	1.50 +0.10/-0
D <sub>1</sub>	1.50±0.10	1.50±0.10	1.50±0.10	1.50±0.10	1.50±0.10	1.50±0.10
E	1.75±0.10	1.75±0.10	1.75±0.10	1.75±0.10	1.75±0.10	1.75±0.10
F	5.50±0.05	5.50±0.05	5.50±0.05	5.50±0.05	5.50±0.05	5.50±0.05
Unit :	mm	mm	mm	mm	mm	mm

Size	2220		2225	
Chip Thickness	1.40±0.15 1.60±0.20 2.00±0.20	2.50±0.30 2.80±0.30	1.60±0.20 2.00±0.20	2.50±0.30 2.80±0.30
A <sub>0</sub>	<5.80	<6.80	<6.80	<6.80
B <sub>0</sub>	<6.50	<6.50	<6.50	<6.50
T	0.30±0.10	0.30±0.10	0.30±0.10	0.30±0.10
K <sub>0</sub>	<2.50	<3.10	<2.50	<3.10
W	12.00±0.20	12.00±0.20	12.00±0.20	12.00±0.20
P <sub>0</sub>	4.00±0.10	4.00±0.10	4.00±0.10	4.00±0.10
10xP <sub>0</sub>	40.00±0.20	40.00±0.20	40.00±0.20	40.00±0.20
P <sub>1</sub>	8.00±0.10	8.00±0.10	8.00±0.10	8.00±0.10
P <sub>2</sub>	2.00±0.05	2.00±0.05	2.00±0.05	2.00±0.05
D <sub>0</sub>	1.50 +0.10/-0	1.50 +0.10/-0	1.50 +0.10/-0	1.50 +0.10/-0
D <sub>1</sub>	1.50±0.10	1.50±0.10	1.50±0.10	1.50±0.10
E	1.75±0.10	1.75±0.10	1.75±0.10	1.75±0.10
F	5.50±0.05	5.50±0.05	5.50±0.05	5.50±0.05
Unit :	mm	mm	mm	mm



9. PACKAGE DIMENSION AND QUANTITY

9.2. REEL DIMENSIONS

Size	01R5	0201, 0402, 0603, 0805, 1206, 1210	1808, 1812, 1825, 2220, 2225	
Reel size	7"	7"	13"	7"
C	13.0 ±0.05	13.0 +0.5/-0.2	13.0 +0.5/-0.2	13.0 +0.7/-0.3
W <sub>1</sub>	8.4 +1.5	8.4 +1.5	8.4 +1.5	12.4 +2.0/-0
W	14.4max	14.4max	14.4max	shall accommodate tape width without interference
A	178.0 ±0.20	178.0 ±0.20	330.0 ±1.0	178.0 ±0.20
N	60.0 +1.0/-0	60.0 +1.0/-0	100 ±1.0	60.0 +1.0/-0

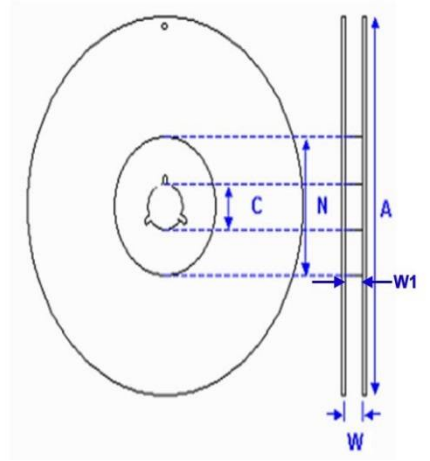

Fig. 9.3 The dimension of reel



## 10. APPLICATION NOTES

### STORAGE

To prevent the damage of solderability of terminations, the following storage conditions are recommended :

Indoors under 5 ~ 40°C and 20% ~ 70% RH.

No harmful gases containing sulfuric acid, ammonia, hydrogen sulfide or chlorine.

Packaging should not be opened until the capacitors are required for use. If opened, the pack should be re-sealed as soon as is practicable. Taped product should be stored out of direct sunlight, which might promote deterioration in tape or adhesion performance. The product is recommended to be used within 12 months after shipment and checked the solderability before use.

### HANDLING

Chip capacitors are dense, hard, brittle, and abrasive materials. They are liable to suffer mechanical damage, in the form of cracks or chips. Chip Capacitors should be handled with care to avoid contamination or damage. To use vacuum or plastic tweezers to pick up or plastic tweezers is recommended for manual placement. Tape and reeled packages are suitable for automatic pick and placement machine.

### PREHEAT

In order to minimize the risk of thermal shock during soldering, a carefully controlled preheat is required. The rate of preheat should not exceed 3°C per second.

### SOLDERING

Use mildly activated rosin fluxes do not use activated flux. The amount of solder in each solder joint should be controlled to prevent the damage of chip capacitors caused by the stress between solder, chips, and substrate.

a.) Hand soldering :

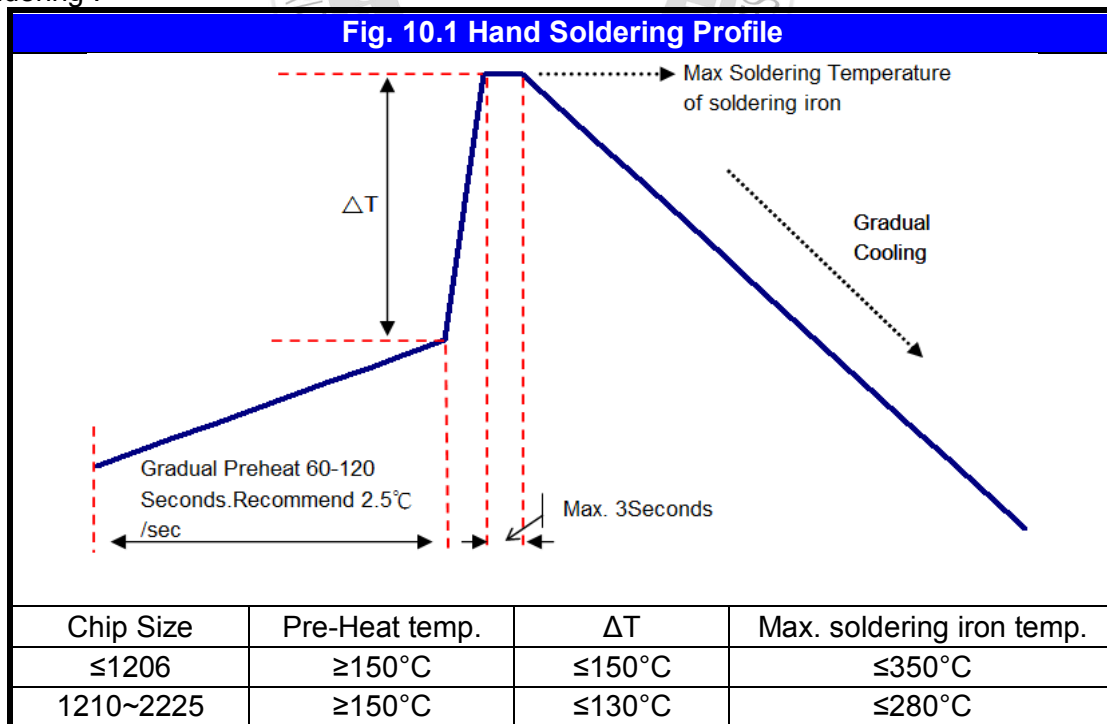

\* Soldering iron tip diameter ≤1.0 mm and wattage max. 20W.

\* The Capacitors shall be pre-heated and that the temperature gradient between the devices and the tip of the soldering iron.

\* The required amount of solder shall be melted on the soldering tip.

\* The tip of iron should not contact the ceramic body directly.

\* The Capacitors shall be cooled gradually at room temperature after soldering.

\* Forced air cooling is not allowed.

10. APPLICATION NOTES

b.) Reflow soldering :

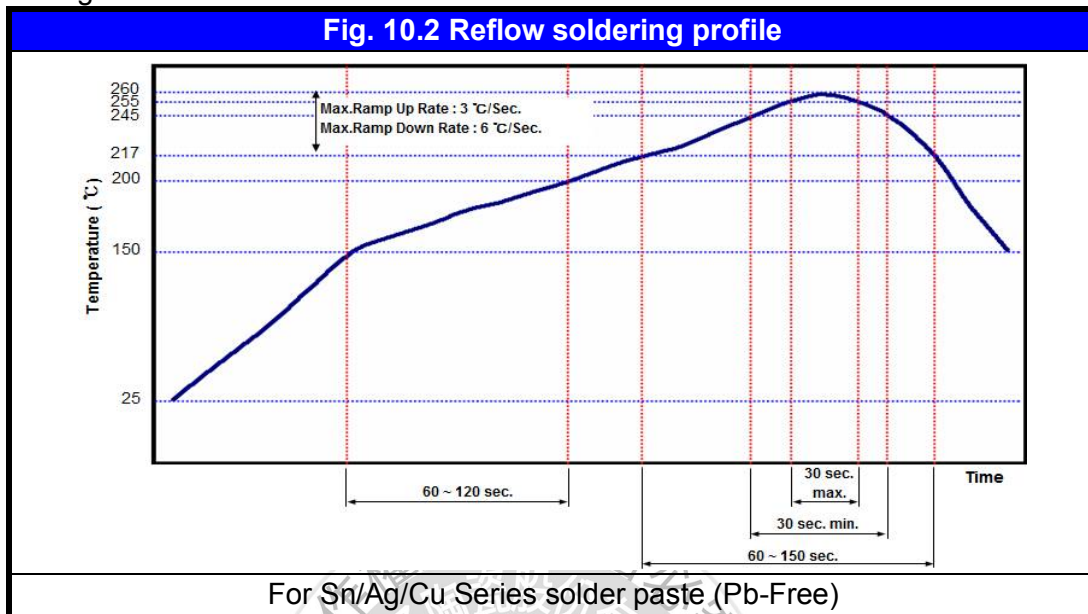

c.) Wave soldering :

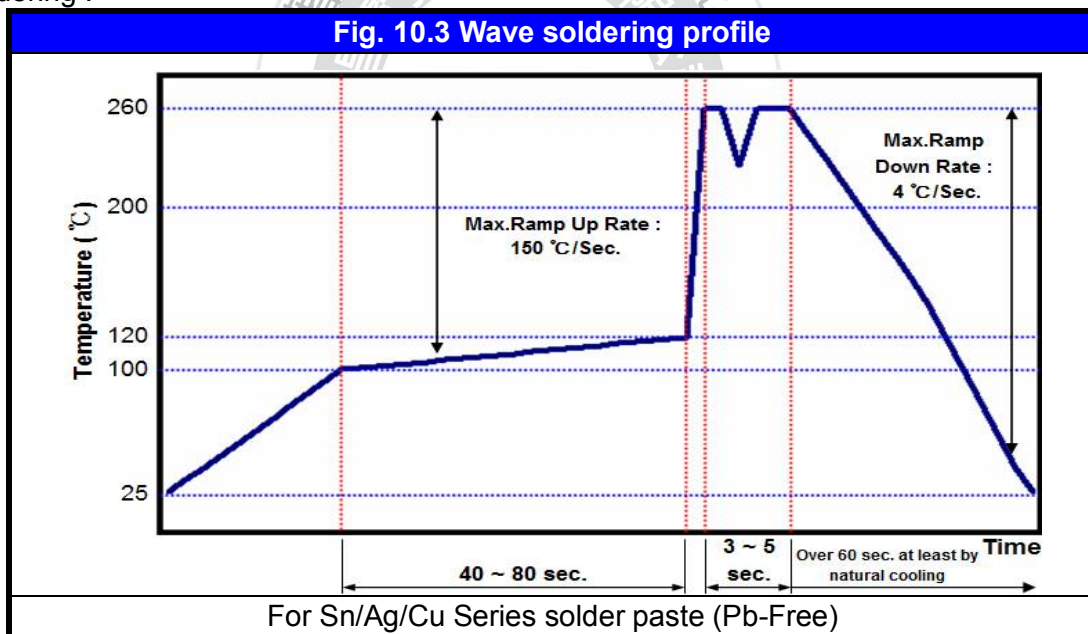

Soldering conditions :

Class I :

Size Inch (mm)	Temper. Cher.	Capacitance	Condition	
			Wave	Reflow
≤0402 (1005)	Class I	All	X	O
0603 (1608)	Class I	All	O	O
0805 (2012)	Class I	All	O	O
1206 (3216)	Class I	All	O	O
		Thickness >0.95mm	X	O
≥1210 (3225)	Class I	All	X	O
Coating Products	All	All	X	O

**10. APPLICATION NOTES**

Soldering conditions :  
Class II :

Size Inch (mm)	Temper. Cher.	Capacitance	Condition	
			Wave	Reflow
≤0402 (1005)	Class II	All	X	O
0603 (1608)	Class II	Cap. <2.2μF	O	O
		Cap. ≥2.2μF	X	O
0805 (2012)	Class II	Thickness ≤ 0.95mm	O	O
		Thickness > 0.95mm	X	O
1206 (3216)	Class II	Thickness ≤ 0.95mm	O	O
		Thickness > 0.95mm	X	O
≥1210 (3225)	Class II	All	X	O
Coating Products	All	All	X	O

Soldering height :

The solder climbing minimum height is suggesting to 25% of chip thickness or 500um whichever is less.  
(Reference from IPC-610E)

The diagram illustrates a cross-section of a chip on a substrate. A vertical double-headed arrow on the left indicates the 'Chip Thickness'. A horizontal dashed line with a downward arrow on the right indicates the 'Soldering Height', which is the height of the solder on the chip's top surface.

**COOLING**

After soldering, cool the chips and the substrate gradually to room temperature. Natural cooling in air is recommended to minimize stress in the solder joint.

**CLEANING**

All flux residues must be removed by using suitable electronic-grade vapor-cleaning solvents to eliminate contamination that could cause electrolytic surface corrosion. Good results can be obtained by using ultrasonic cleaning of the solvent. The choice of the proper system is depends upon many factors such as component mix, flux, and solder paste and assembly method. The ability of the cleaning system to remove flux residues and contamination from under the chips is very important.