

Product Overview

The QPL1821 is an ultra-linear, GaAs pHEMT, differential RF amplifier. The device features a cascode design which provides 19dB of flat gain along with very low distortion from 5MHz to 1.8GHz. This ultra-linear IC is designed to support Broadband CATV DOCSIS 4.0 applications, such as Nodes, Amplifiers, and Remote PHY Devices, as well as Fiber to The Home (FTTH), Home Gateways, and Cable Modems. The device is powered by a single supply that can operate from 5V to 8V and current can be set from 260 mA to 350 mA. At 5V and 260 mA the QPL1821 provides an output of 63dBmV TCP with a MER of 45dB. When driven with 8V and 350mA the output is 67 dBmV TCP with a MER of 45dB. The QPL1821 is packaged in a 12-pin 5x5 mm² Laminate Module

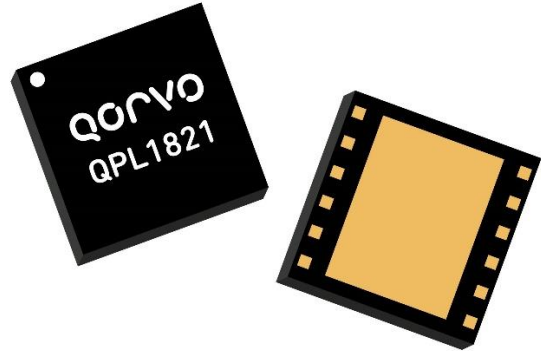

5 x 5 12-pin Laminate MCM Package

Functional Block Diagram

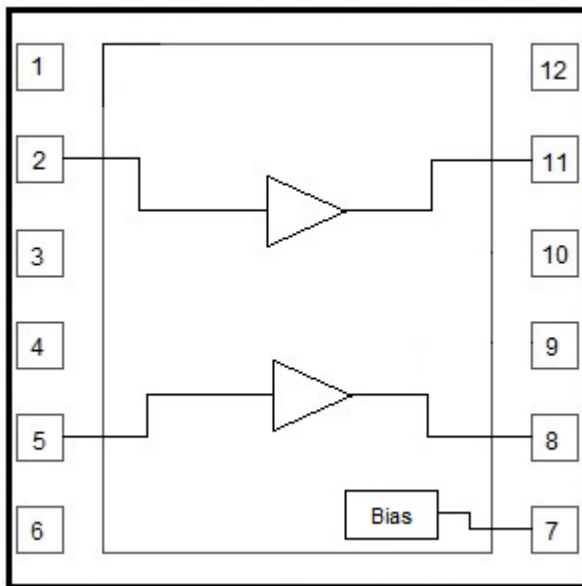

Key Features

- 5 MHz to 1800 MHz Operation
- 5V & 8V Operation
- Gain: 19dB Typical
- TCP: 63dBmV @ 5V
- TCP: 67dBmV @ 8V
- Noise Figure: 1.6/3.2dB @ 50/1800MHz
- Adjustable Bias Using External Resistors
- RoHS Compliant

Applications

- DOCSIS 4.0 Amplifiers
- DOCSIS 4.0 Optical Nodes
- DOCSIS 4.0 Remote PHY Devices
- FTTH GPON and GEPON
- DOCSIS 4.0 Cable Modem and Home Gateways

Ordering Information

Part Number	Description	Part Number	Description
QPL1821EVB-01	5V Downstream Evaluation Board	QPL1821SB	Sample bag with 5 pieces
QPL1821EVB-02	5V Upstream Evaluation Board	QPL1821SR	7" Reel with 100 pieces
QPL1821EVB-03	8V Downstream Evaluation Board	QPL1821TR13	13" Reel with 2500 pieces
QPL1821EVB-04	8V Upstream Evaluation Board		

Absolute Maximum Ratings

Parameter	Rating
Supply Voltage (V _{DD})	+10 V
Supply Current (I _{DD})	400 mA
Maximum Input Level	+65 dBmV
Operating Temperature Range (Operating Device Heat Slug Temperature)	-40 to +100 °C
Storage Temperature Range	-65 to +150 °C
Maximum Junction Temperature	+150 °C

Exceeding any one or a combination of the Absolute Maximum Rating conditions may cause permanent damage to the device. Extended application of Absolute Maximum Rating conditions to the device may reduce device reliability.

Electrical Specifications (Downstream)

Parameter	Test Condition	Min	Typ	Max	Unit
Supply Voltage (V _{DD})			5/8		V
Supply Current (I _{DD})			260/350		mA
Frequency Range		50		1800	MHz
Gain at 50 MHz			18		dB
Gain at 1800 MHz			19		dB
Gain Slope			1		dB
Reverse Isolation			23		dB
Input Return Loss	50 – 1200 MHz		-22		dB
	1200 – 1800 MHz		-20		dB
Output Return Loss	50 – 1200 MHz		-22		dB
	1200 – 1800 MHz		-20		dB
MER	At +63dBmV @ 5V and +67dBmV @ 8V Total Composite Output power. 108 to 1791MHz, 280 Ch, SC-QAM, 10dB tilt, 0dB Offset (Source corrected)		45		dB
Noise Figure	50MHz		1.6		dB
	1800MHz		3.2		
OIP2L	+12 dBm / tone output, Δf=53MHz, Full Band		85		dBm
OIP2U	+12 dBm / tone output, Δf=53MHz, Full Band		70		dBm
OIP3	+12 dBm / tone output, Δf=6MHz, Full Band		42/45		dBm
OP1dB	50-1800MHz		27/30		dBm
Thermal Resistance	ΘJC (Junction to Device Heat Slug)		12		°C/W

Note: Typical performance at these conditions: Temp = +25 °C, V_{DD} = +5 V, 75 Ω system, Full band unless otherwise noted

Evaluation Board Schematic 50 MHz – 1800 MHz (Downstream)

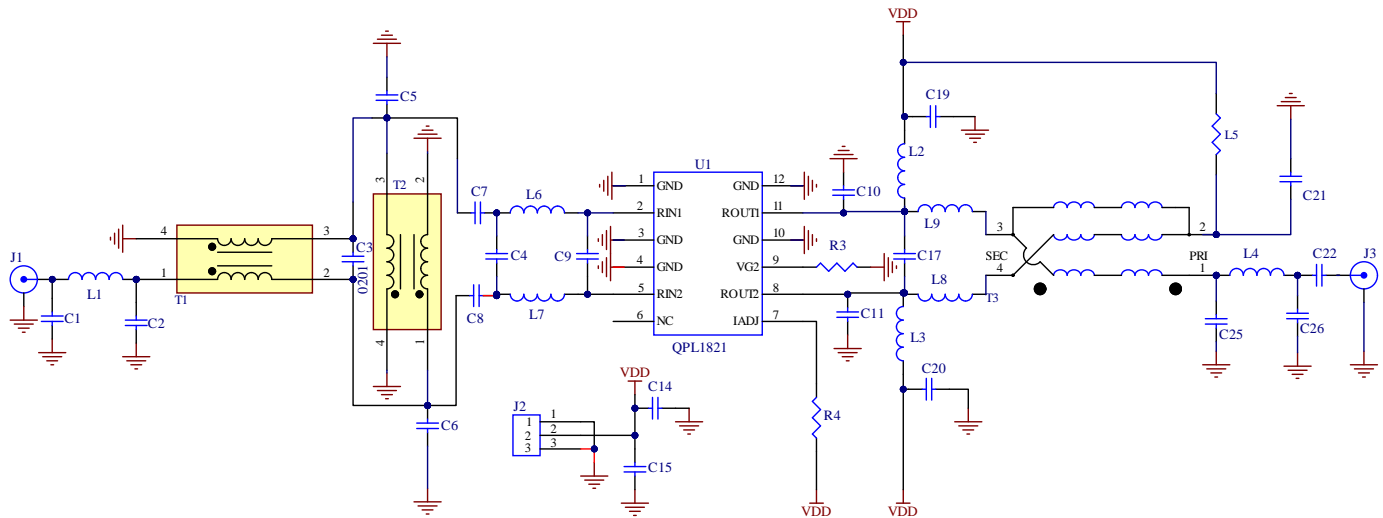

Evaluation Board Assembly Drawing (Downstream)

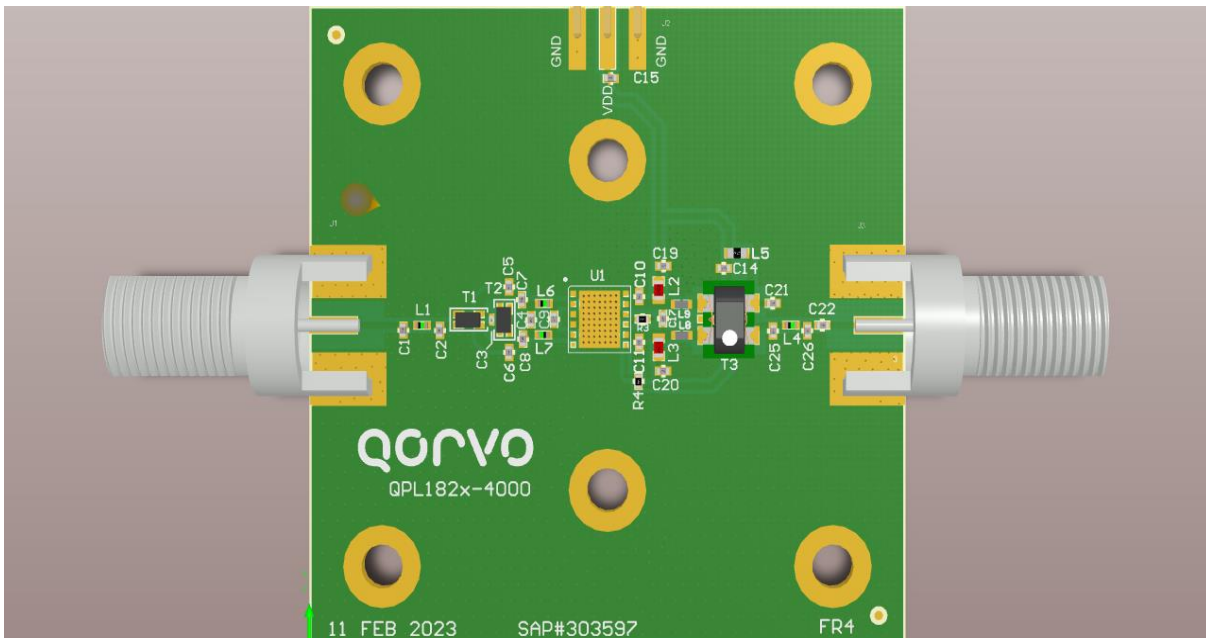

Materials: Isola370HR High-Tg FR4

Layer	Thickness	Primary Stack	Description	Dk / Df
Layer - 1	0.0010		Taiyo 4000-HFX DI 1/2oz Mix (Std Plt)	3.50 / 0.0190
	0.0020			4.34 / 0.0180
Layer - 2	0.0578	0.0590 (8-7628)	370H 1/2oz Mix (Std Plt)	4.34 / 0.0180
	0.0020			



Evaluation Board Bill of Materials for Downstream 5V

Ref Des	Description	Manufacturer	Part Number
PCB	PCB, QPL182X-4000	Qorvo	QPL1823-4000(A)
C3	CAP, 0.3pF, +/-0.1pF, 25V, HI-Q, 0201	MURATA	GJM0335C1ER30BB01D
C4	CAP, 0.7pF, +/-0.1pF, 50V, HI-Q, 0402	MURATA	GJM1555C1HR70BB01D
C10, C11	CAP, 0.6pF, +/-0.1pF, 50V, HI-Q, 0402	MURATA	GJM1555C1HR60BB01D
C7, C8	CAP, 1000pF, 5%, 50V, COG, 0402	MURATA	GRM1555C1H102JA01D
C14, C19, C20, C21	CAP, 0.01uF, 10%, 50V, X7R, 0402	MURATA	GCM155R71H103KA55D
C22	CAP, 470pF, 5%, 50V, COG, 0402	MURATA	GRM1555C1H471JA01D
C15	CAP, 0.1uF, 10%, 25V, X7R, 0402	MURATA	GRM155R71E104KE14D
C2	CAP, 0.3pF, 0.1pF, 50V, COG, HI-Q	MURATA	GJM1555C1HR30BB01D
L8, L9	RES, 0 OHM, 5%, 1/10W, 0402	Kamaya, Inc	RMC1/16SJPTH
R3	RES, 3.3K, 5%, 1/16W, 0402	Kamaya, Inc	RMC1/16S-332JTH
R4	Res, 1.3K /1%/0402/TK100/Chip	Kamaya, Inc	RMC1/16SK1301FTH
L1, L4	IND, 1nH, +/-0.3nH, M/L, 0402	MURATA	LQG15HN1N0S02D
L6, L7	IND, 1.8nH, ±0.2nH, W/W, HI-Q, 0402	MURATA	LQW15AN1N8C00D
U1	1.8GHz 5V, Push Pull, 19dB gain	Qorvo	QPL1821
L2, L3	FER, BEAD, 1500 OHM, 500mA, 0603	MURATA	BLM18HE152SN1D
T1, T2	BALUN, 1GHz ~ 1.5GHz, 75 / 75 OHM	MURATA	DXW21BN7511SL07
T3	Transformer - 10-1800MHz, 75 ohms	Mini Circuits	TRS1-182-75-7+
J2, J3	CONN, HDR, ST, 3-PIN, 0.100"	SAMTEC INC.	TSW-103-07-G-S
J1, J4	CONN, F FEM EDGE MOUNT, 75R	Millimeter Wave	MW-846-C-DD-75
HS	HEATSINK, 50 x 50 x10, ALUMINUM	Alpha Nova Tech	S08EFV05-A
C1 ,C5, C6, C9, C17, C25, C26, L5	NOT POPULATED ITEMS		DUMMY PART

BOM Changes for Downstream 8V Operation

R4	RES, 2.0K OHM, 5%, 1/16W, 0402	Kamaya	RMC1/16-202JTH
----	--------------------------------	--------	----------------

Electrical Specifications (Upstream)



Parameter	Condition (1)	Min	Typ	Max	Unit
Supply Voltage (VDD)			5/8		V
Supply Current (IDD)			260/350		mA
Frequency Range		5		700	MHz
Gain at 5 MHz			18		dB
Gain at 700 MHz			18		dB
Gain Slope			0		dB
Reverse Isolation			24		dB
Input Return Loss	5 – 700MHz		-20		dB
Output Return Loss	5 – 700MHz		-20		dB
MER	At +66dBmV @ 5V and +69dBmV @ 8V Total Composite Output power. 5MHz to 700MHz, 112 Ch, SC-QAM, 0dB tilt, 0dB Offset (Source corrected)		45		dB
Noise Figure	5-700MHz		1.5		dB
OIP2L	+12 dBm / tone output, $\Delta f=53$ MHz, Full Band		90		dBm
OIP2U	+12 dBm / tone output, $\Delta f=53$ MHz, Full Band		80		dBm
OIP3	+12 dBm / tone output, $\Delta f=6$ MHz, Full Band		43/46		dBm
OP1dB	5-700MHz		27/30		dBm
Thermal Resistance	Θ_{JC} (Junction to Device Heat Slug)		12		$^{\circ}\text{C}/\text{W}$

Note: Typical performance at these conditions: Temp = +25 $^{\circ}\text{C}$, V_{DD} = +5 V, 75 Ω system, Full band unless otherwise noted

Evaluation Board Schematic 5 MHz – 700 MHz (Upstream)

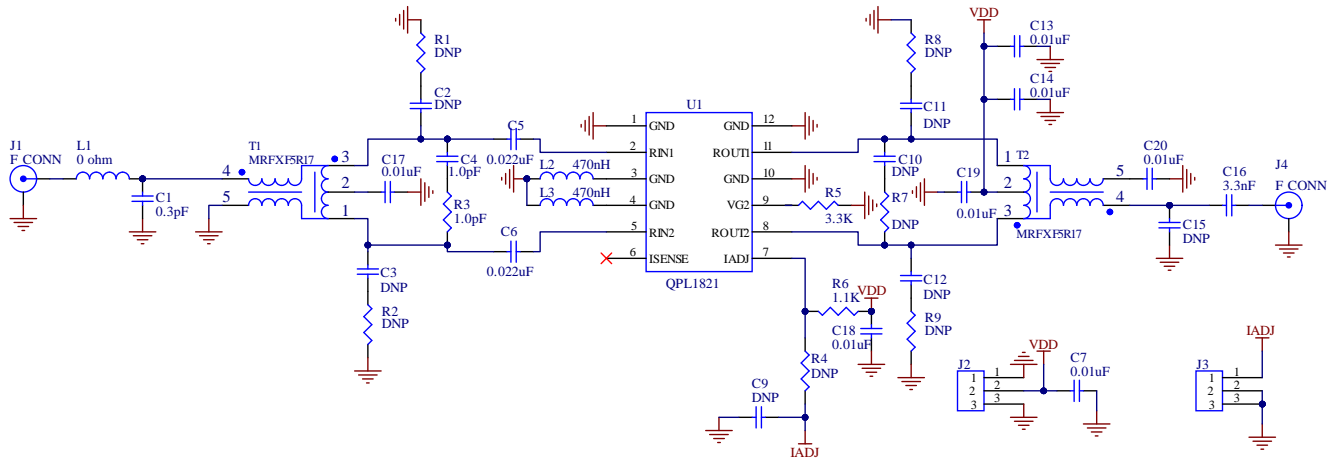

Evaluation Board Assembly Drawing (Upstream)

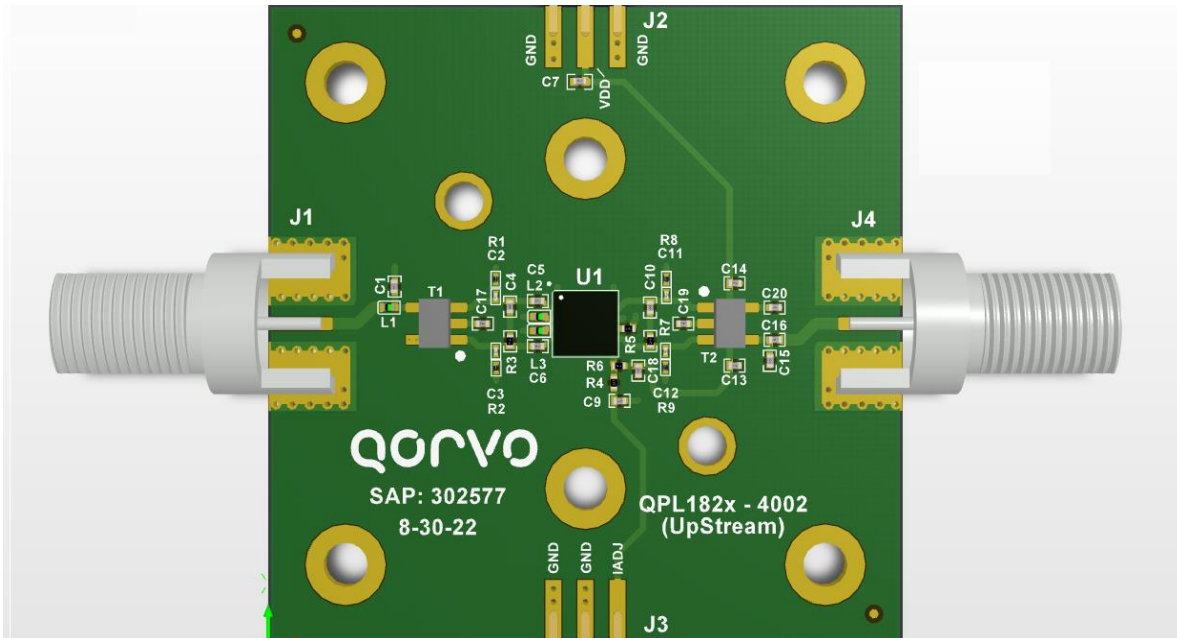

Materials: Isola370HR High-Tg FR4

Layer	Thickness	Primary Stack	Description	Dk / Df
Layer - 1	0.0010 0.0020		Taiyo 4000-HFX DI 1/2oz Mix (Std Plt)	3.50 / 0.0190
Layer - 2	0.0578 0.0020		0.0590 (8-7628)	370H 1/2oz Mix (Std Plt)



Evaluation Board Bill of Materials for Upstream 5V

Ref Des	Description	Mfg Name	Mfg Part #
PCB	PCB, QPL182X-4002	Qorvo	QPL1820-4002(A)
C1	CAP, 0.3pF, +/-0.1pF, 25V, 0201	MURATA	GJM0335C1ER30BB01D
C7, C13, C14, C17, C18, C19, C20	CAP, 0.01uF, 10%, 50V, X7R, 0402	MURATA	GCM155R71H103KA55D
C4, R3	CAP, 1pF, +/-0.05pF, 50V	MURATA	GJM1555C1H1R0WB01D
C5, C6	CAP, 0.022uF, 10%, 50V, X7R, 0402	MURATA	GCM155R71H223KA55D
C16	CAP, 3300pF, 10%, 50V, X7R, 0402	Kemet	C0402C332K5RACTU
L1	RES, 0 OHM, 5%, 1/10W, 0402	Kamaya, Inc	RMC1/16SJPTH
R5	RES, 3.3K, 5%, 1/16W, 0402	Kamaya, Inc	RMC1/16S-332JTH
R6	RES, 604 OHM, 1%, 1/10W, 0402	Kamaya, Inc	RMC1/16SK6040FTH
L2, L3	IND, 470nH, 5%, 310mA	Coilcraft, Inc.	0402AF-471XJLW
U1	1.8GHz 5V, Push Pull, 19dB gain	Qorvo	QPL1821
T1,T2	XFMR, BALUN, 1:1, 5-700MHz, 75R	Mini-RF, Inc.	MRFXF5R17
J2,J3	CONN, HDR, ST, 3-PIN, 0.100"	SAMTEC INC.	TSW-103-07-G-S
J1,J4	CONN, F FEM EDGE MOUNT, 75R	Millimeter Wave	MW-846-C-DD-75
HS	HEATSINK, 50 x 50 x10, ALUMINUM	Alpha Nova	S08EFV05-A
C2, C3, C9, C10, C11, C12, C15, R1, R2, R4, R7, R8, R9	NOT POPULATED ITEMS		DUMMY PART

BOM Changes for Upstream 8V Operation

R6	RES, 1.1K OHM, 1%, 1/16W, 0402	KOA	RK73H1ETTP1101F
----	--------------------------------	-----	-----------------

Performance Data, Downstream 5V

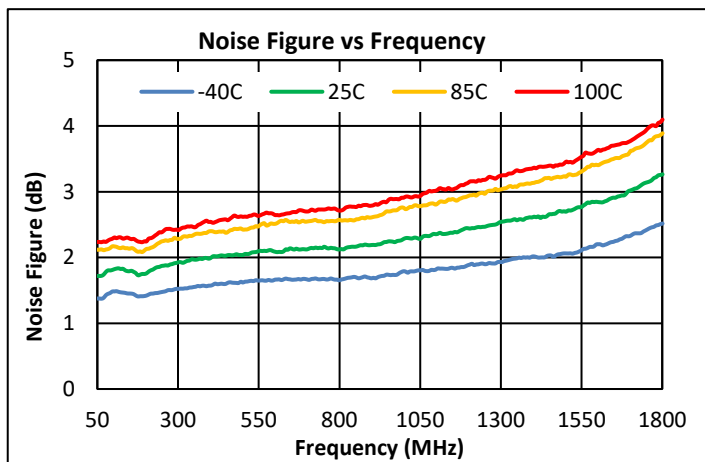
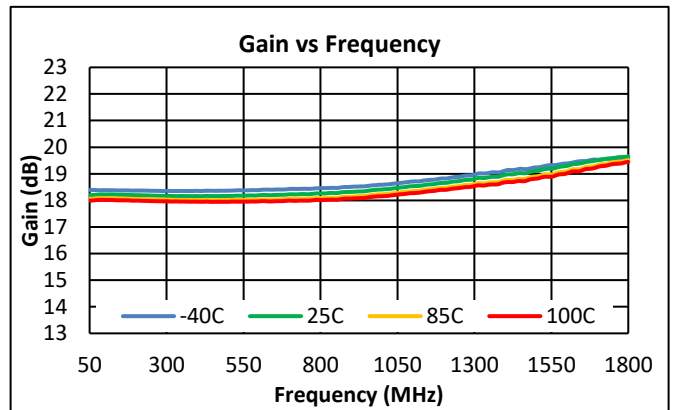
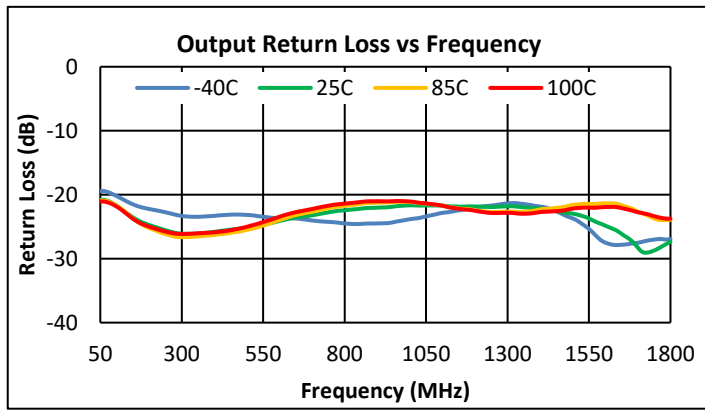
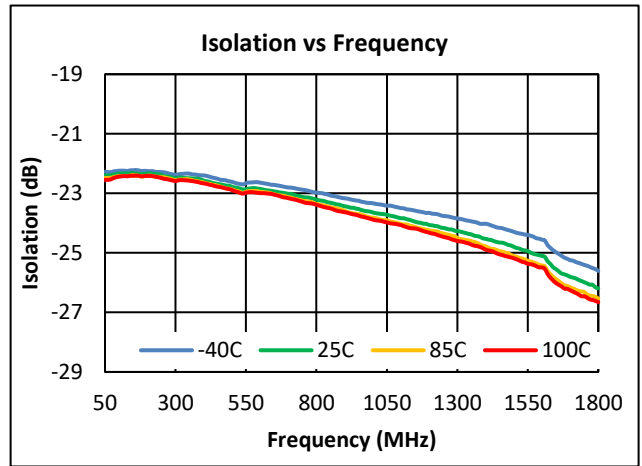
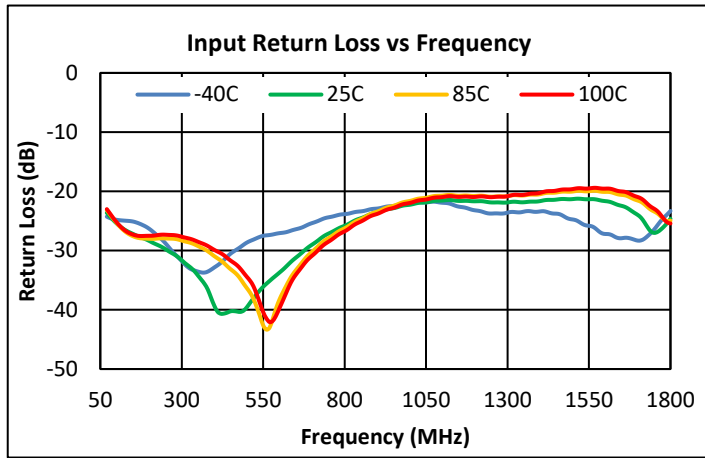

Performance Data, Downstream 5V (cont'd)

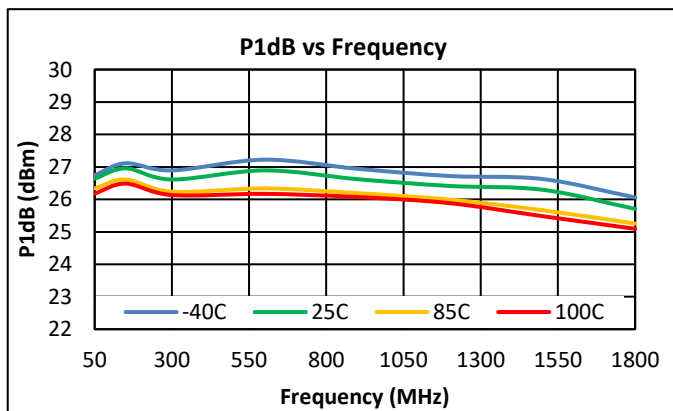
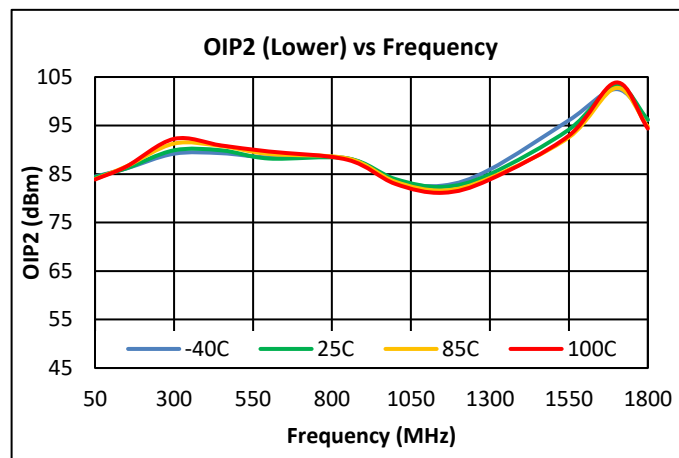
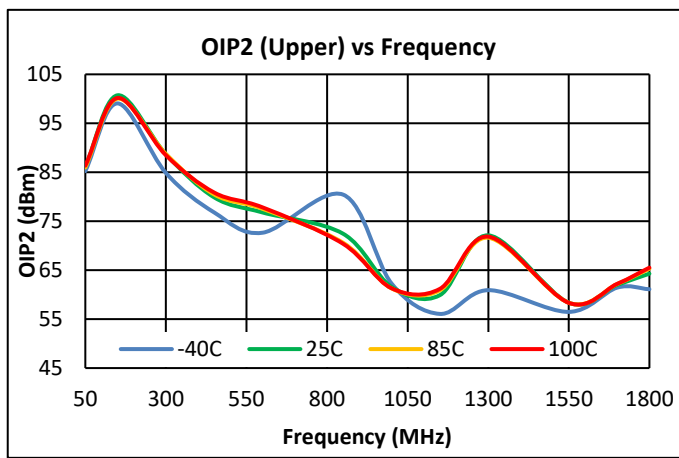
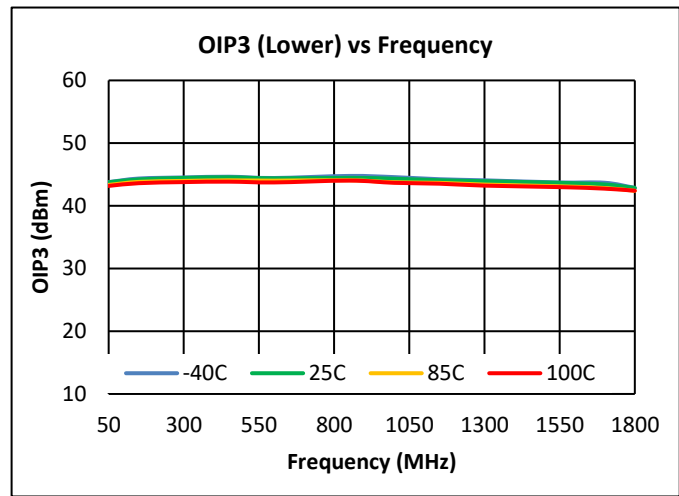
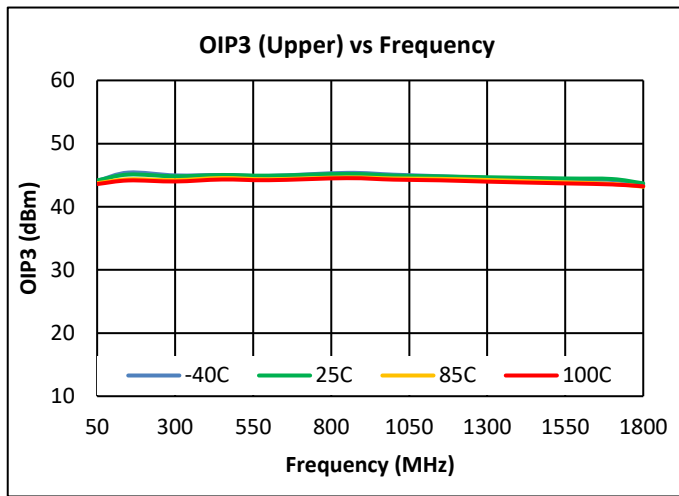

Notes:

- (1) 5V OIP3: +12dBm / tone output @ $\Delta f = 6\text{MHz}$
- (2) 5V OIP2: +12dBm / tone output @ $\Delta f = 53\text{MHz}$

Performance Data, Downstream 5V (cont'd)

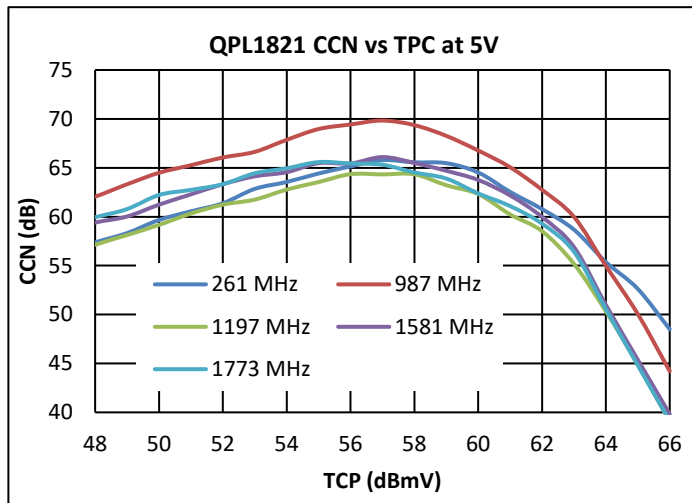
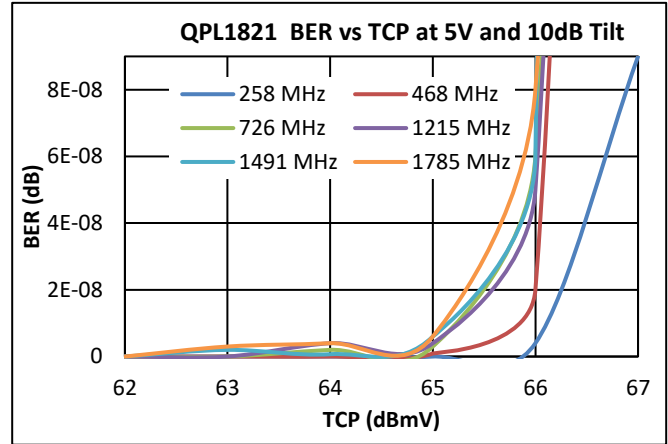
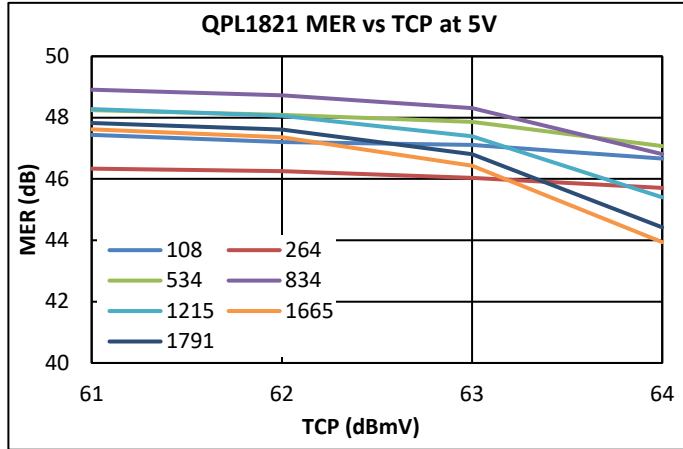

Notes:

- (1) MER & BER Test Conditions: (261 – 1791 MHz, 280 Ch SC-QAM, 10dB tilt, 0dB offset)
- (2) MER is uncorrected
- (3) CCN Test conditions: 10dB tilt, 6dB offset at 1.026GHz, 261-1791MHz loading

Performance Data, Downstream 8V

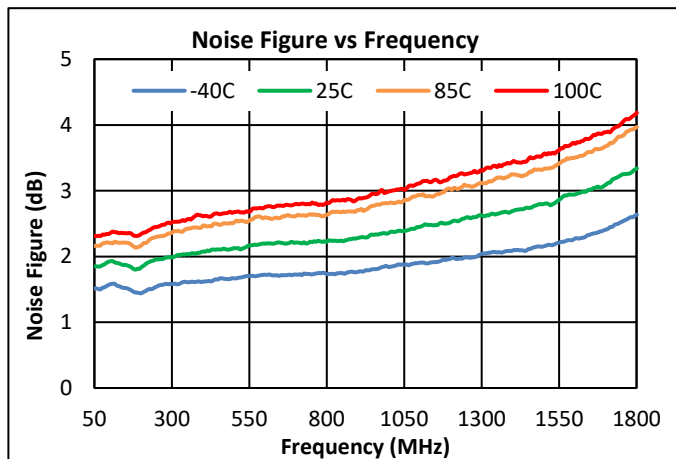
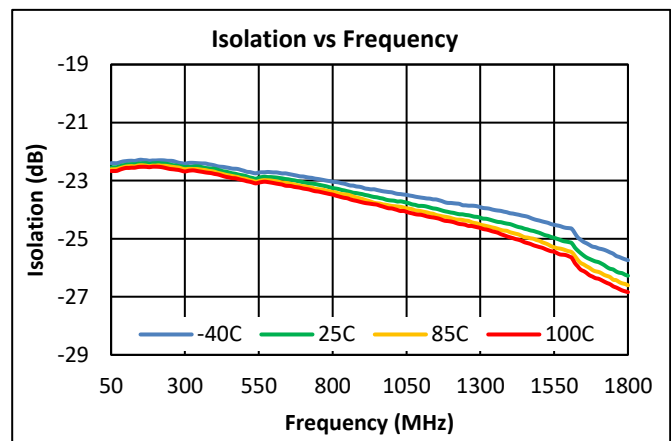
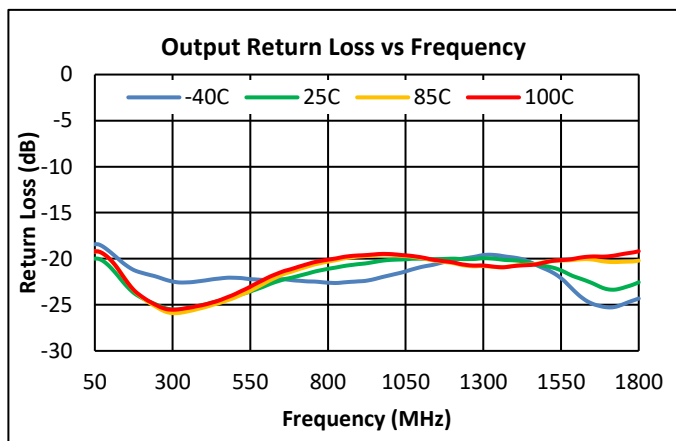
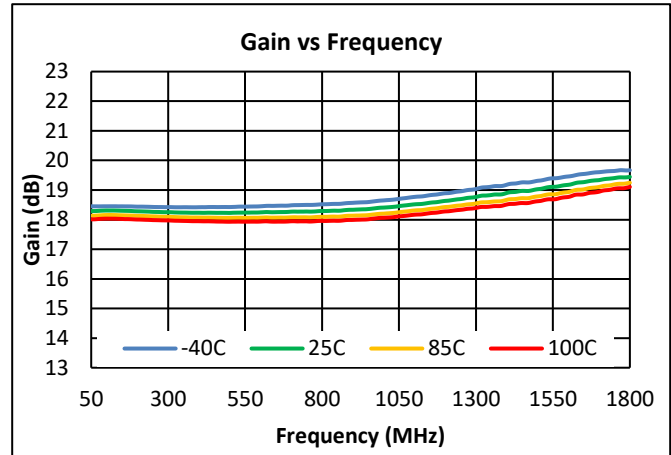
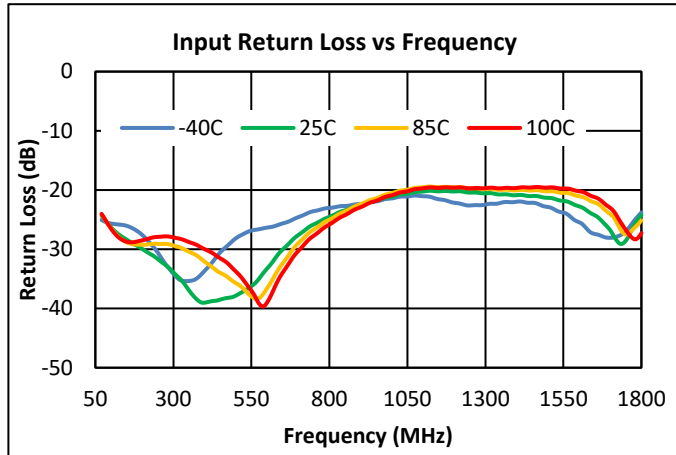

Performance Data, Downstream 8V (Cont'd)

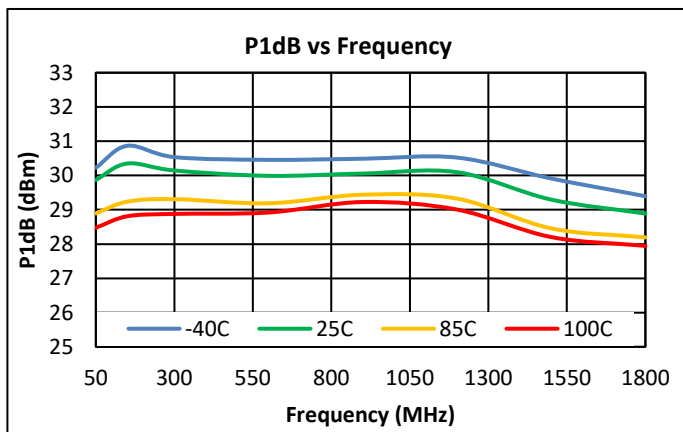
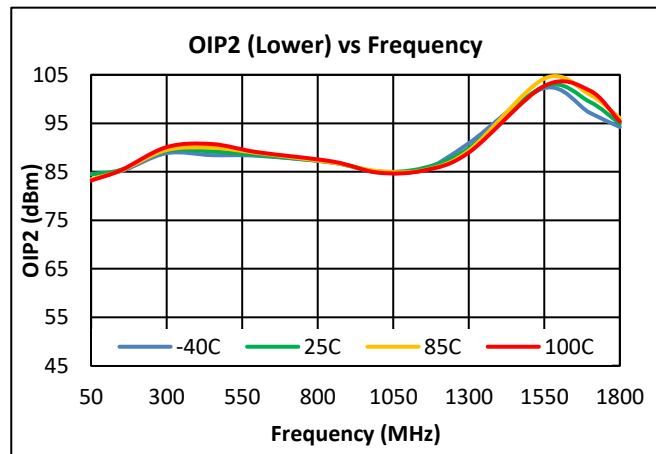
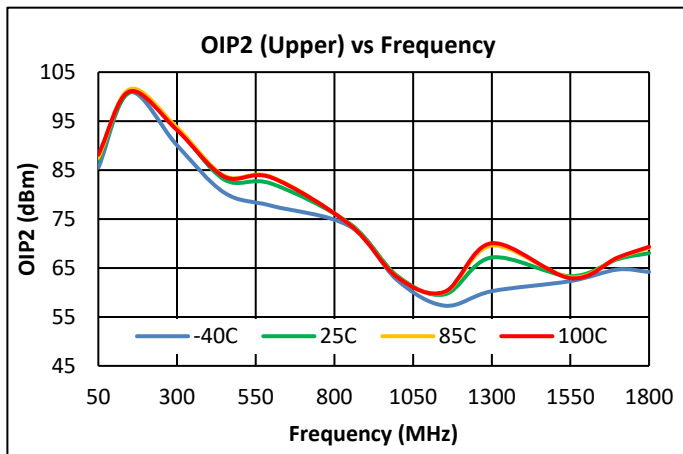
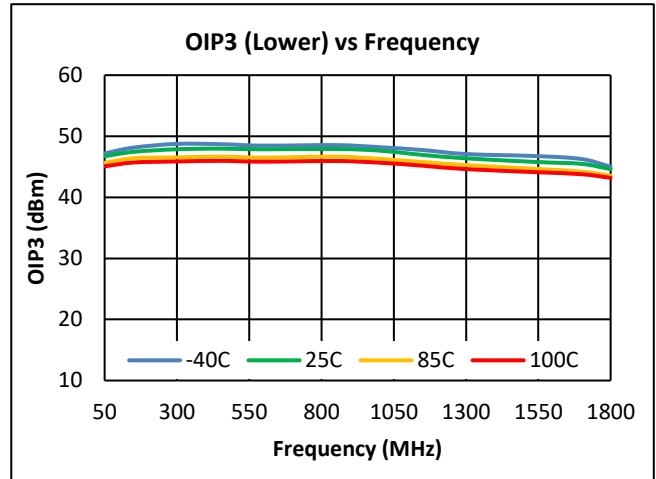
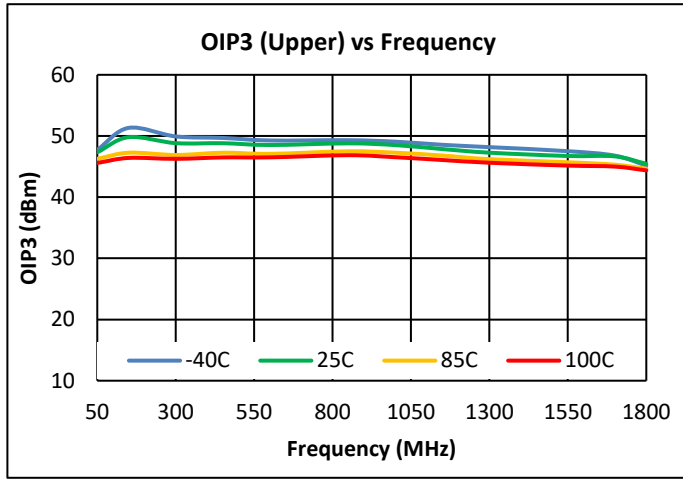

Notes:

- (1) 8V OIP3: +15dBm /tone output @ Δf = 6MHz
- (2) 8V OIP2: +15dBm/tone output @ Δf = 53MHz

Performance Data, Downstream 8V (Cont'd)

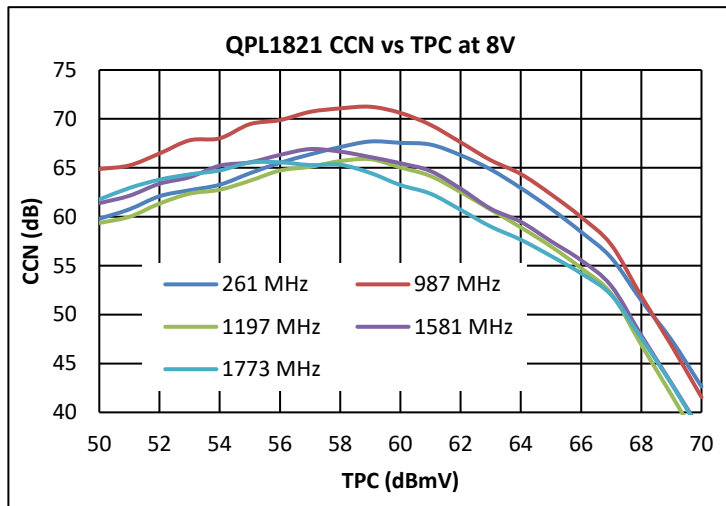
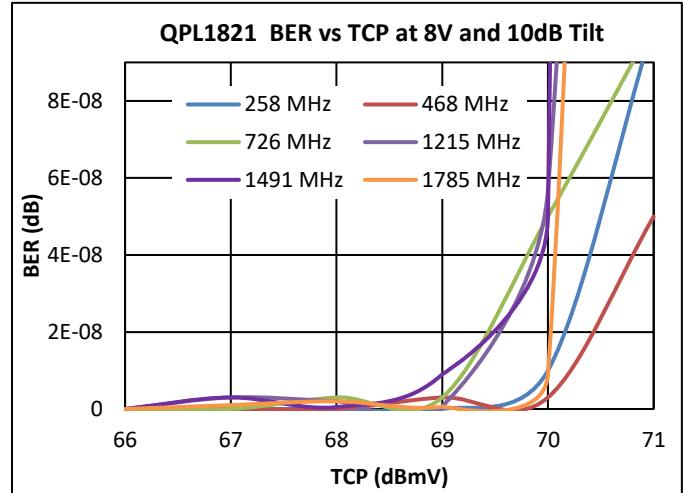
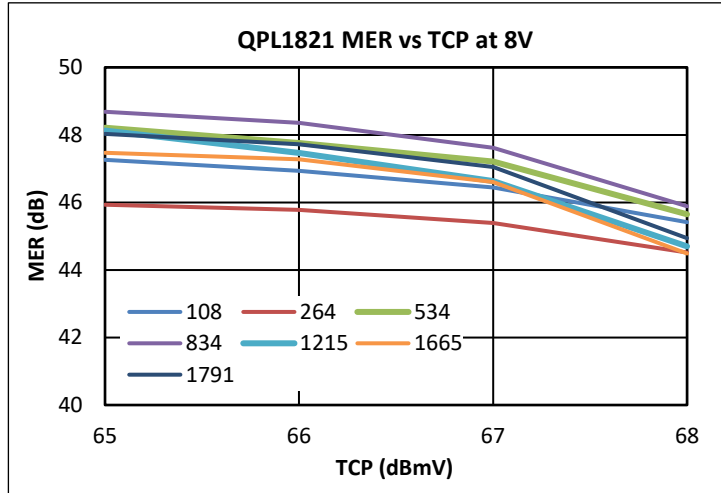

Notes:

- (1) MER & BER Test Conditions: (261 – 1791 MHz, 280 Ch SC-QAM, 10dB tilt, 0dB offset)
- (2) MER is uncorrected
- (3) CCN Test conditions: 10dB tilt, 6dB offset at 1.026GHz, 261-1791MHz loading

Performance Data, Upstream 5V

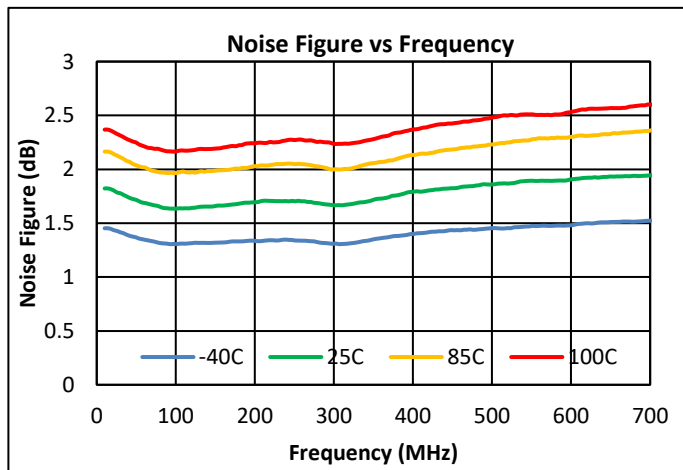
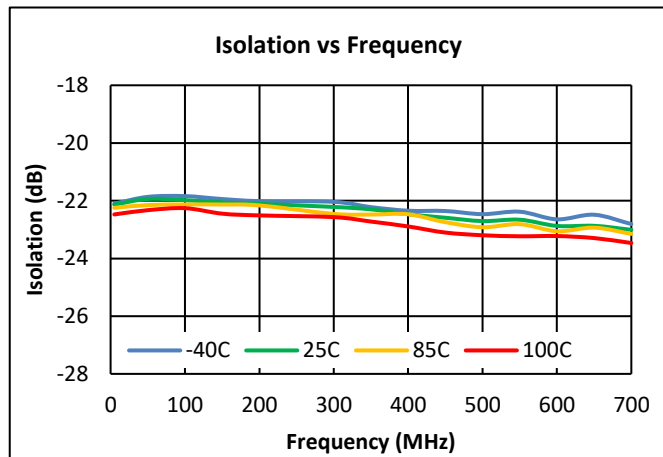
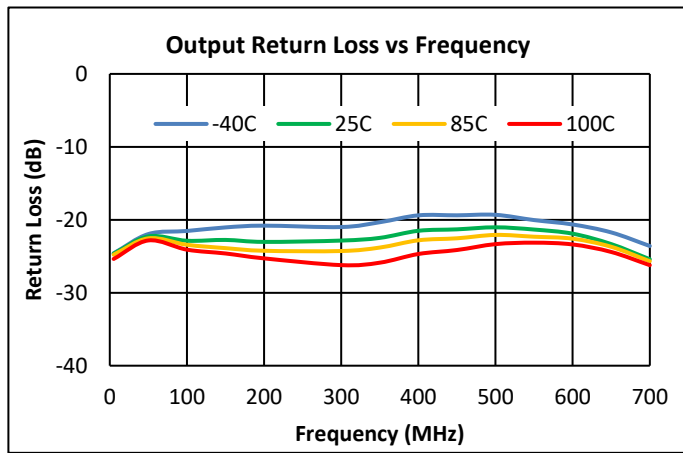
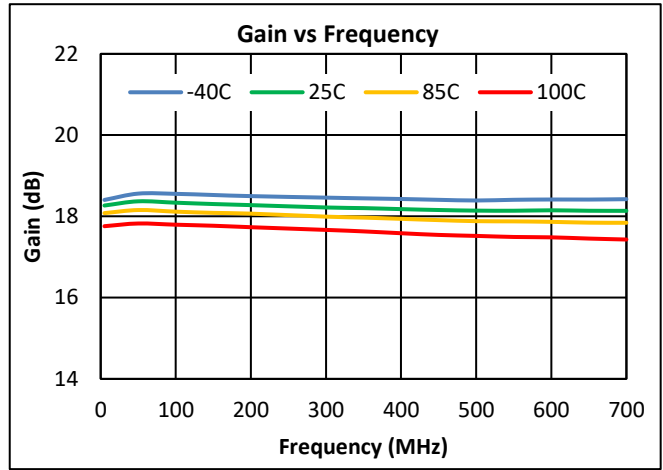
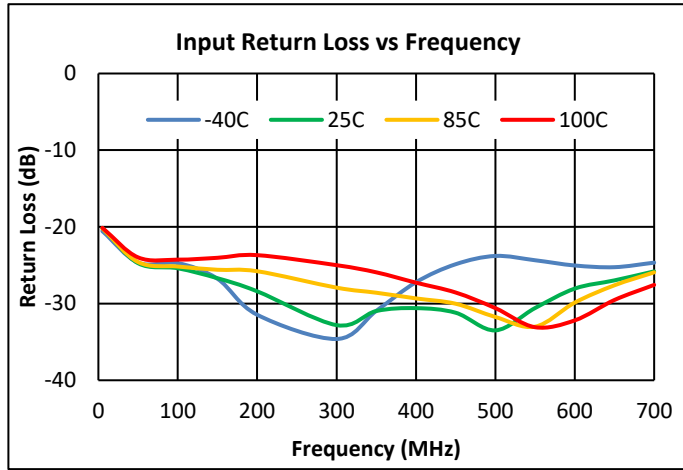

Performance Data, Upstream 5V (Cont'd)

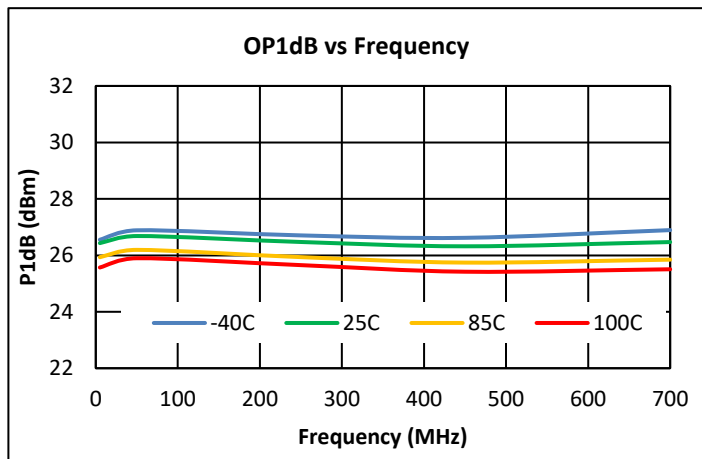
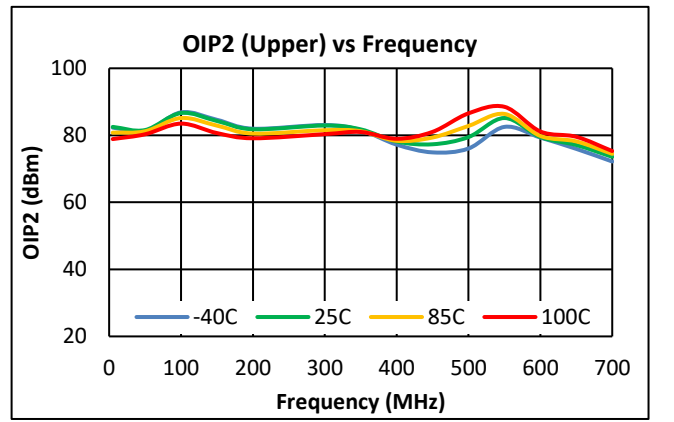
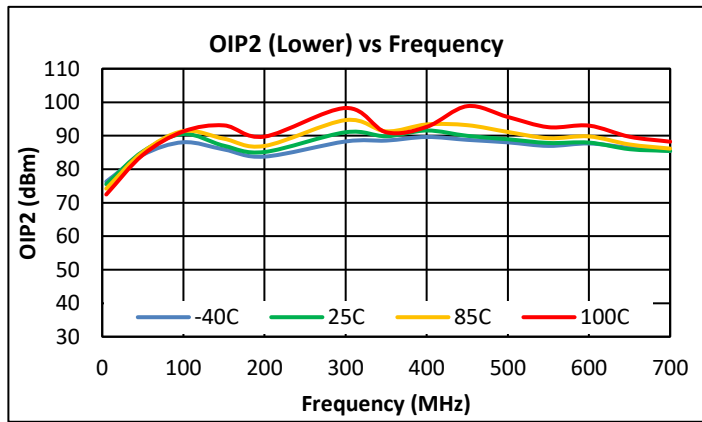
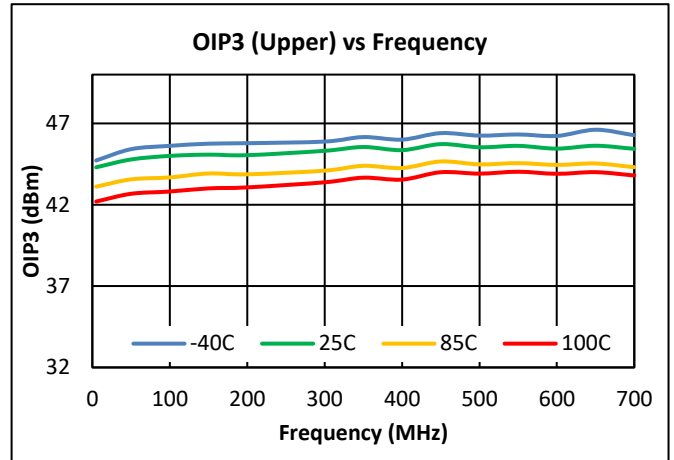
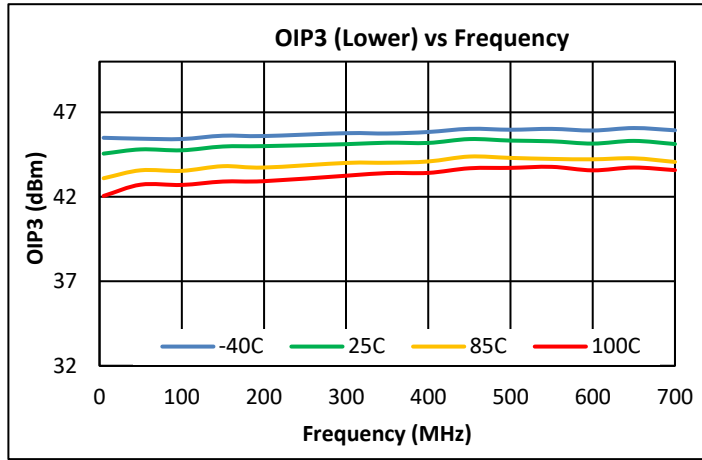

Notes:

- (1) 5V OIP3: +12dBm / tone output @ $\Delta f = 6\text{MHz}$
- (2) 5V OIP2: +12dBm / tone output @ $\Delta f = 53\text{MHz}$

Performance Data, Upstream 5V (Cont'd)

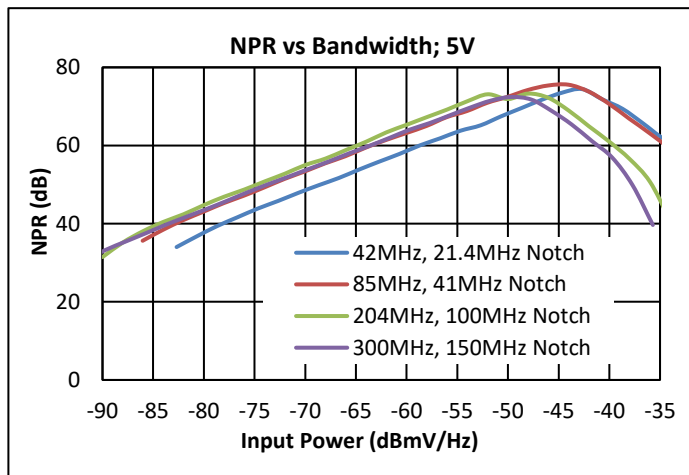
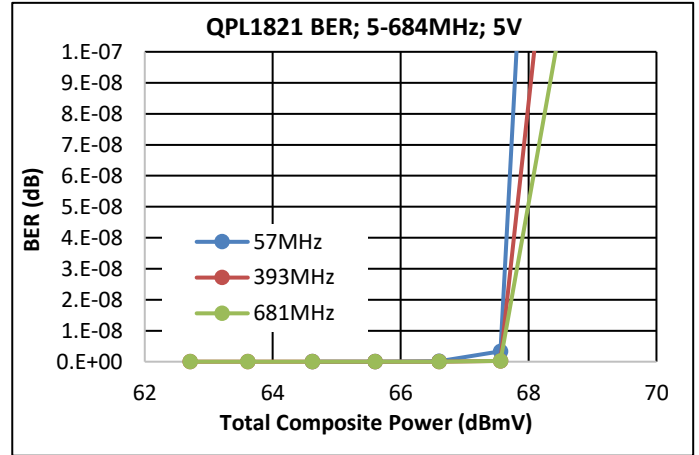
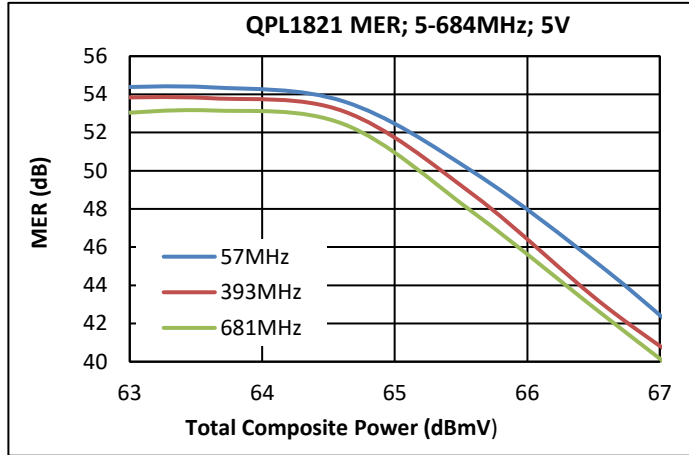

Notes:

- (1) MER & BER Test Conditions: (5 – 694 MHz, 111 Ch SC-QAM, 0dB tilt)
- (2) MER is source corrected

Performance Data, Upstream 8V

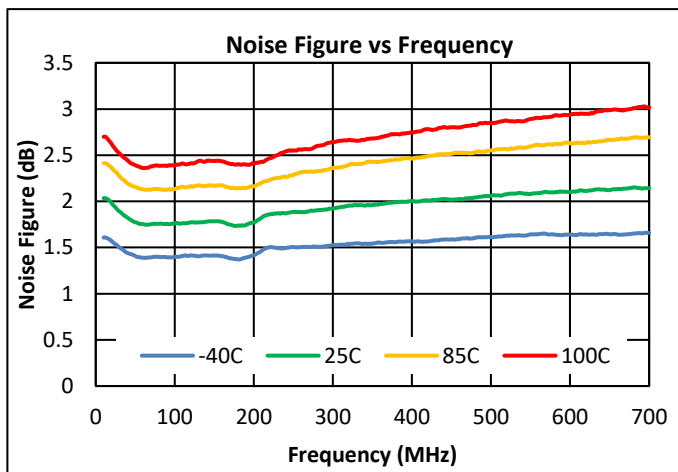
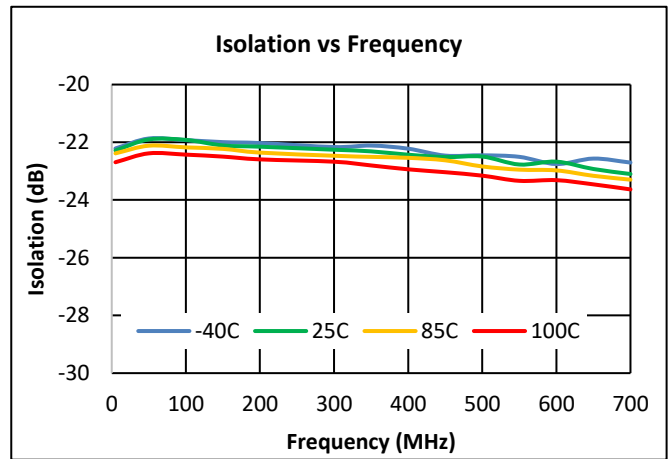
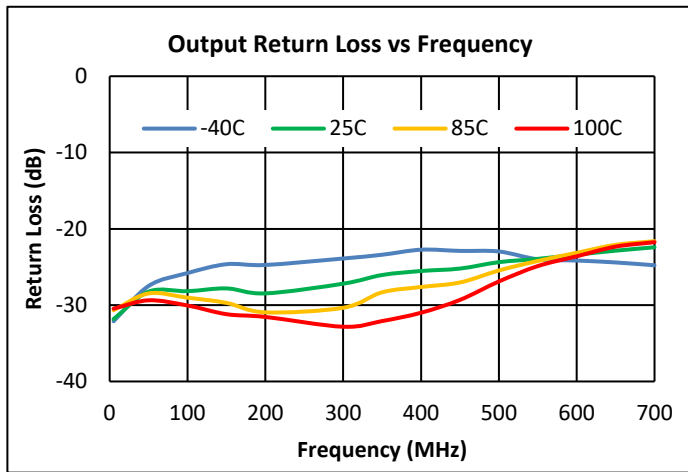
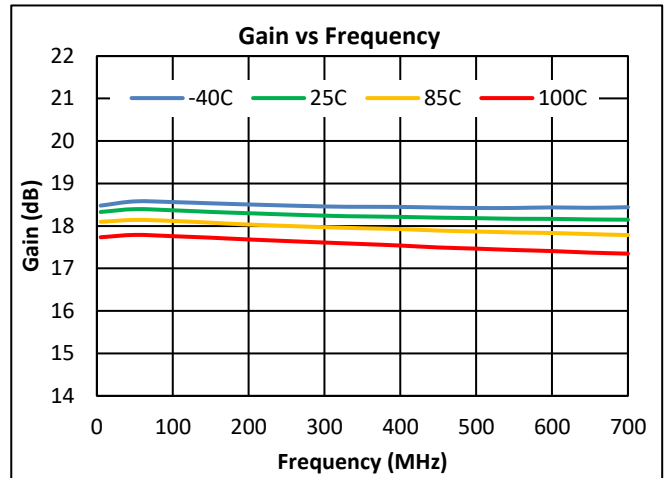
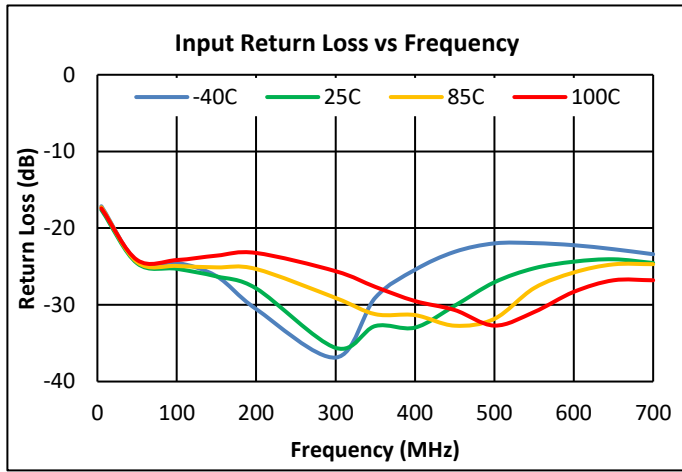

Performance Data, Upstream 8V (Cont'd)

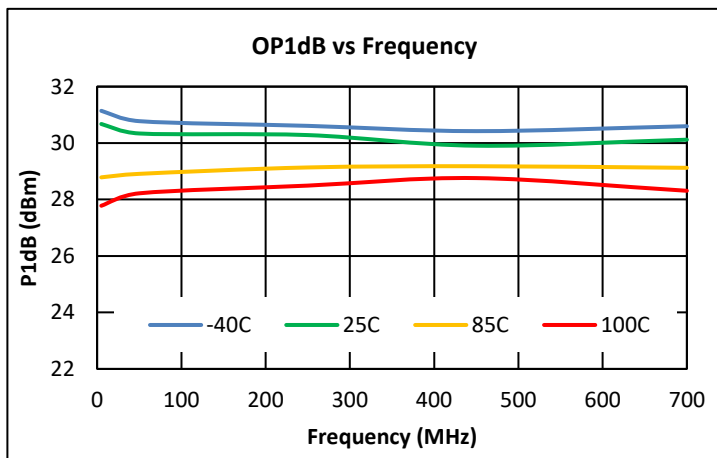
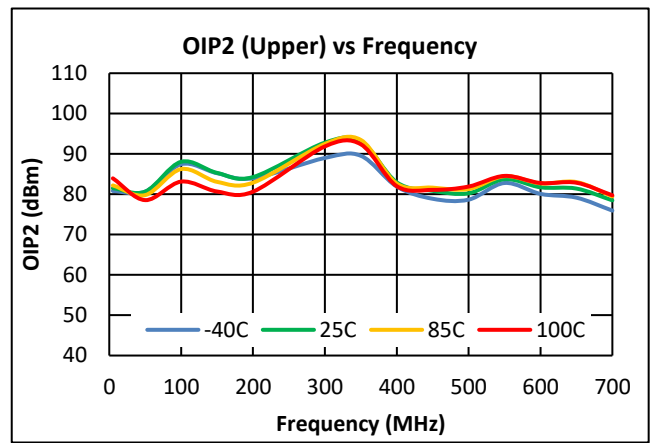
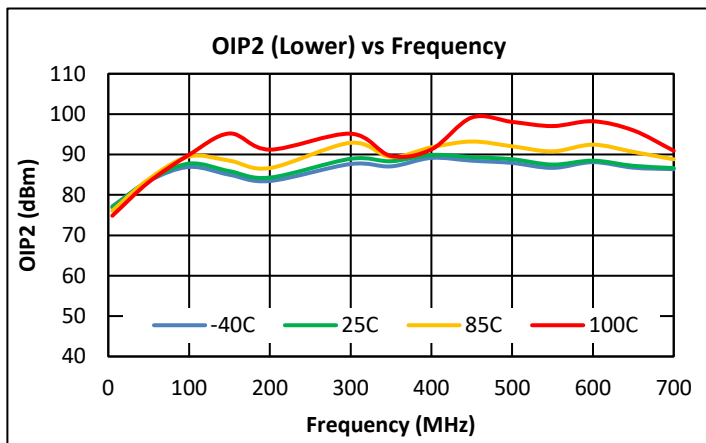
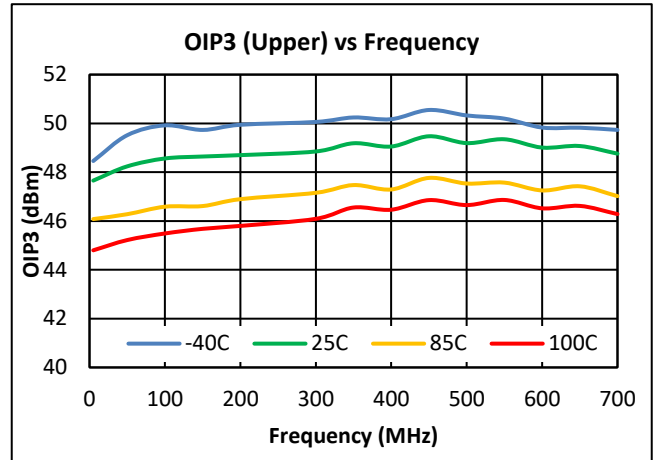
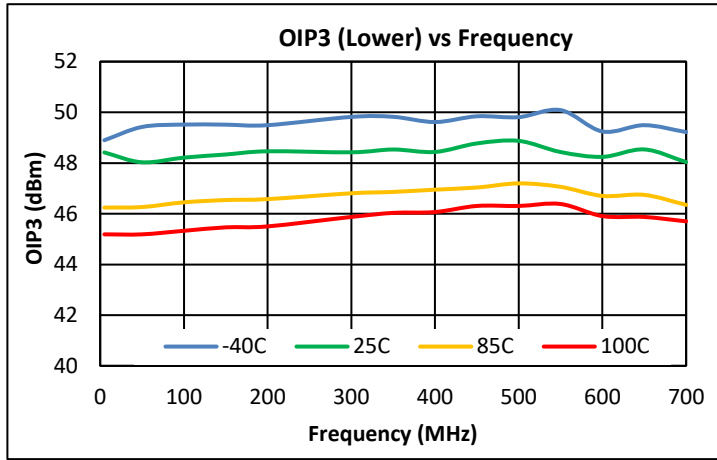

- Notes:
- (1) 8V OIP3: +15dBm / tone output @ $\Delta f = 6\text{MHz}$
 - (2) 8V OIP2: +15dBm/tone output @ $\Delta f = 53\text{MHz}$

Performance Data, Upstream 8V (Cont'd)

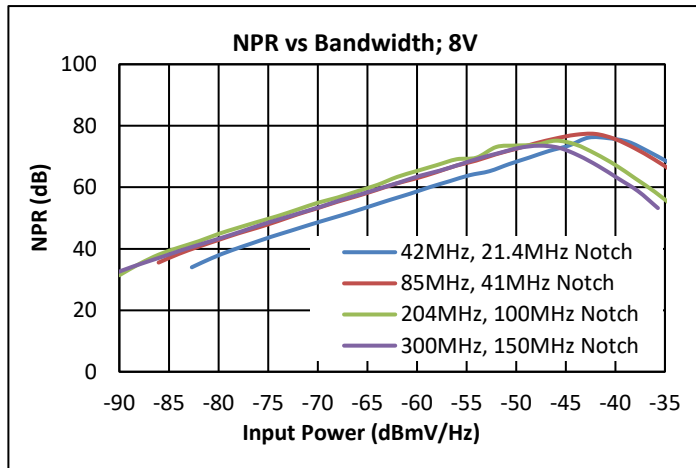
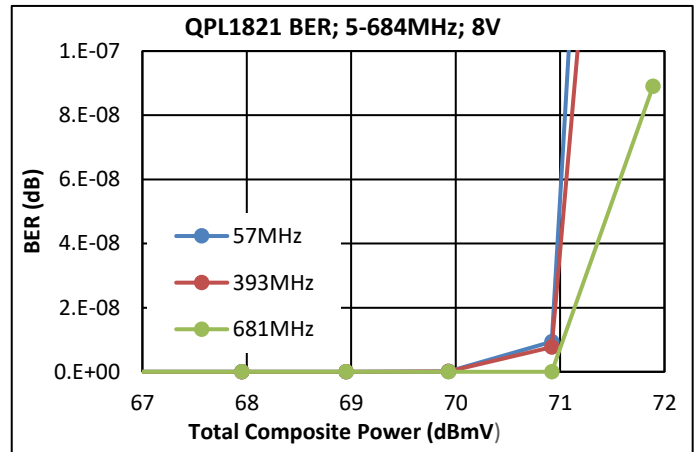
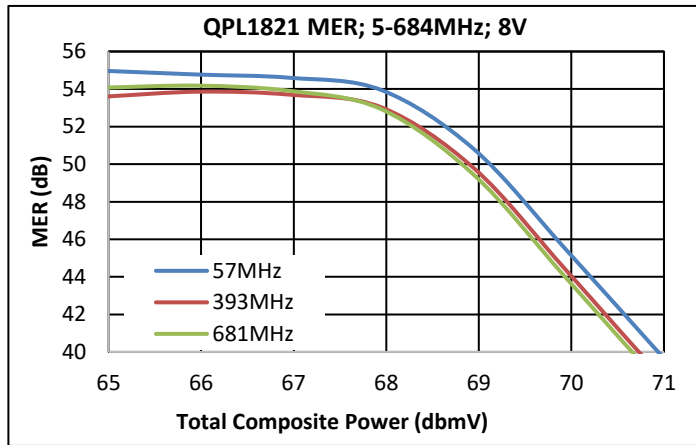

Notes:

- (1) MER & BER Test Conditions: (5 – 694 MHz, 111 Ch SC-QAM, 0dB tilt)
- (2) MER is corrected

IADJ Resistor Value

The Resistor Rbias is used to set the device current. In the application circuit, the value of Rbias is set to get an IDD of 260mA which is optimal for linearity at 5V. In applications where higher linearity is required, or higher supply rail is present, the IDD can be adjusted by varying the value of Rbias. (See graph below for downstream application)

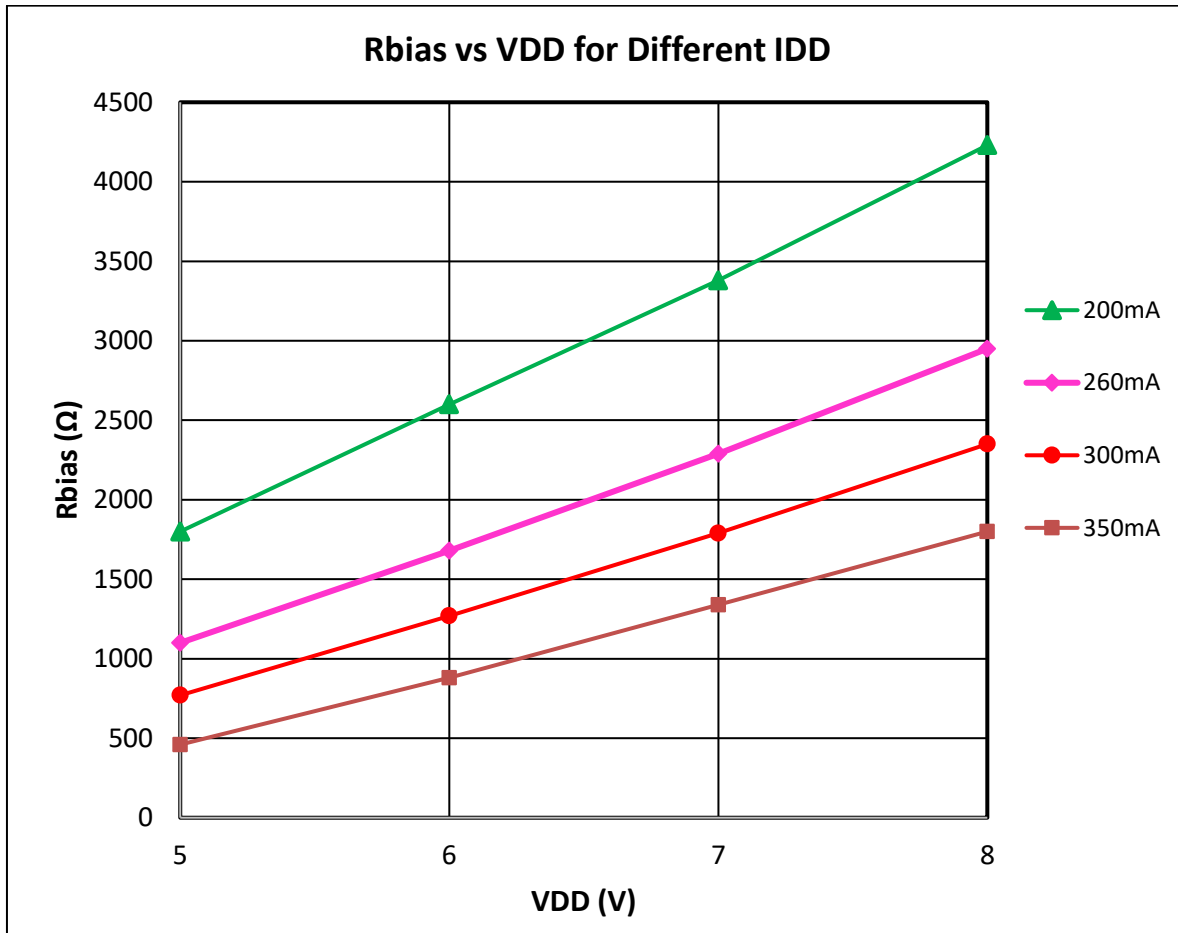

Pin Configuration and Description

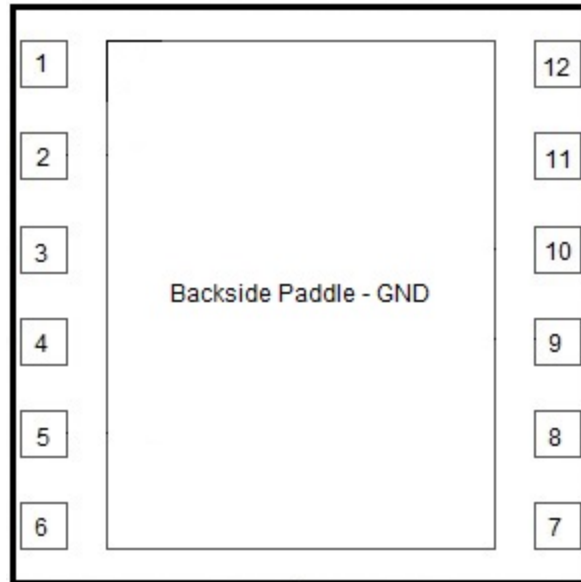

5 x 5 12-pin Laminate MCM

Pin Number	Label	Description
1	NC	No internal connection, recommend connecting to EVB GND
2	RFIN+	RF Input +
3	GND	Must be connected to EVB GND
4	GND	Must be connected to EVB GND
5	RFIN-	RF input -
6	NC	No connect pin. Leave it open. Do not connect to GND.
7	IADJ	IDD current set
8	RFOUT-/VDD2	RF output - and VDD through RF Choke
9	VG2	Cascode device bias resistor divider
10	NC	No internal connection, recommend connecting to EVB GND
11	RFOUT+/VDD	RF output + and VDD through RF Choke
12	NC	No internal connection, recommend connecting to EVB GND
Paddle	GND	DC/RF/Thermal/GND. (Maximize vias in this area)

Package Outline

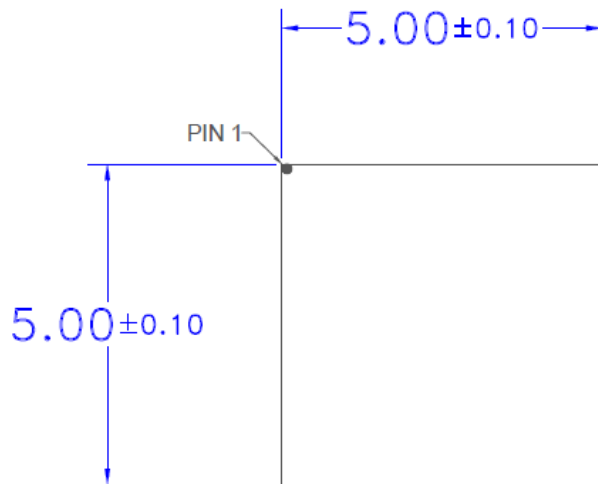

TOP VIEW

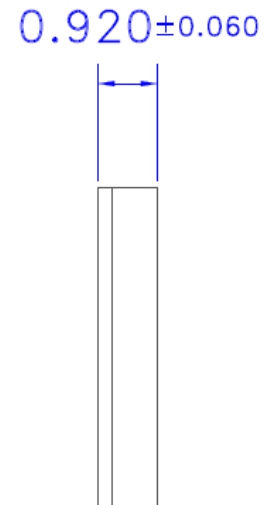

SIDE VIEW

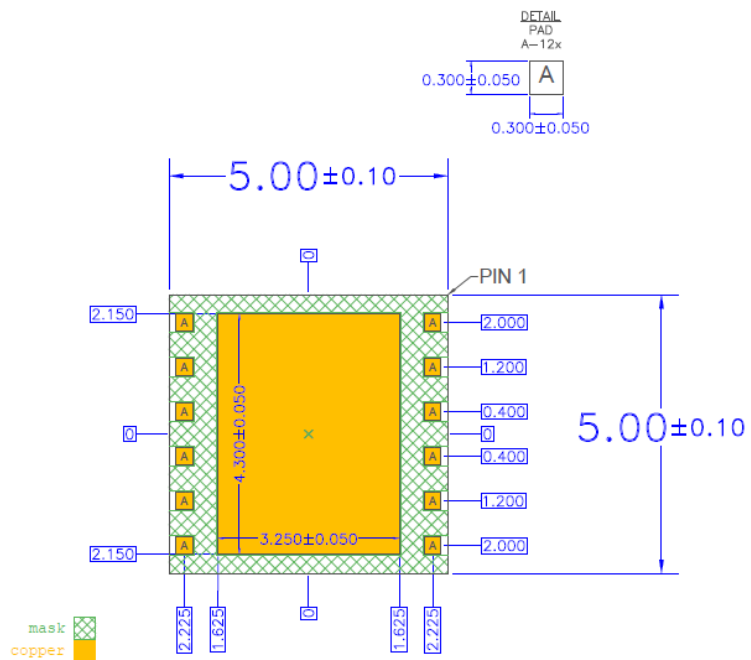

BOTTOM VIEW

Package Marking

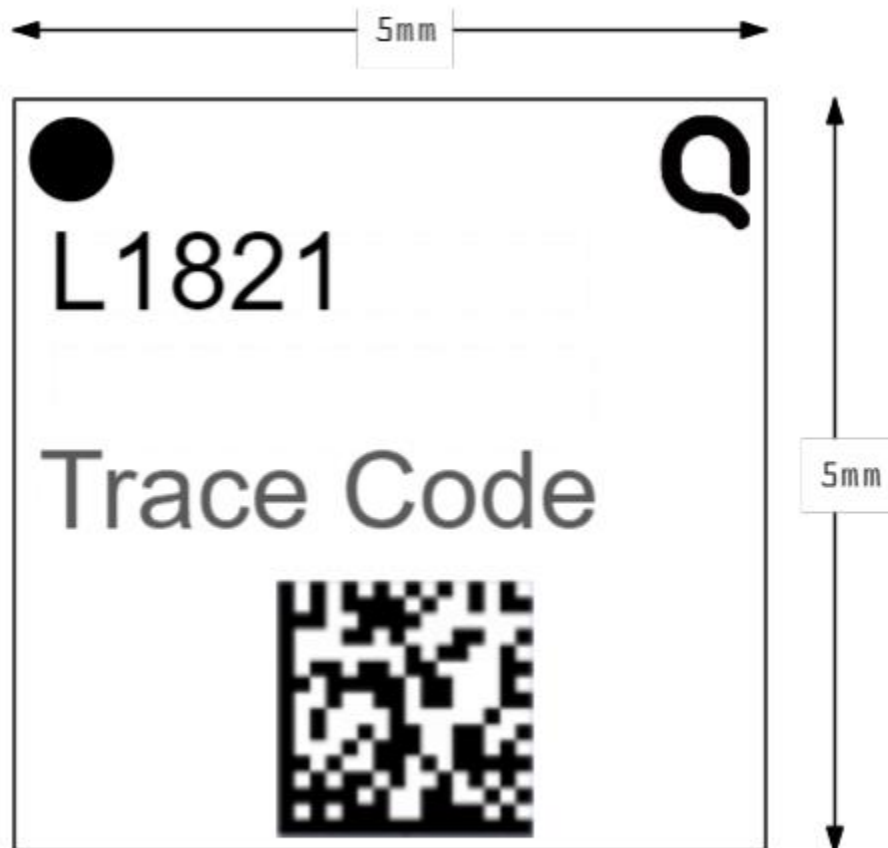

- Pin 1 Indicator
Qorvo Logo - Use Q5D
Trace Code to be assigned by SubCon

Handling Precautions

Parameter	Rating	Standard	 Caution! ESD Sensitive Device
ESD – Human Body Model (HBM)	Class 1B (500V to <1000V)	ANSI / ESDA / JEDEC JS-001	
ESD – Charged Device Model (CDM)	Class C3 ($\geq 1000V$)	ANSI / ESDA / JEDEC JS-002	
MSL – Moisture Sensitivity Level	MSL3	IPC / JEDEC J-STD-020	

Solderability

Compatible with both lead-free (260 °C max. reflow temp.) and tin / lead (245 °C max. reflow temp.) soldering processes.
 Solder profiles available upon request.

Contact plating: ENEPIG

RoHS Compliance

This part is compliant with 2011/65/EU RoHS directive (Restrictions on the Use of Certain Hazardous Substances in Electrical and Electronic Equipment) as amended by Directive 2015/863/EU.

This product also has the following attributes:

- PFOS Free
- Halogen Free (Chlorine, Bromine)
- Antimony Free
- TBBP-A (C₁₅H₁₂Br₄O₂) Free
- SVHC Free

Contact Information

For the latest specifications, additional product information, worldwide sales and distribution locations:

Tel: 1-844-890-8163

Web: www.qorvo.com

Email: customer.support@qorvo.com



QPL1821

75 Ω 19 dB CATV Amplifier (5 – 1800MHz)

Important Notice

The information contained herein is believed to be reliable; however, Qorvo makes no warranties regarding the information contained herein and assumes no responsibility or liability whatsoever for the use of the information contained herein. All information contained herein is subject to change without notice. Customers should obtain and verify the latest relevant information before placing orders for Qorvo products. The information contained herein or any use of such information does not grant, explicitly or implicitly, to any party any patent rights, licenses, or any other intellectual property rights, whether with regard to such information itself or anything described by such information. **THIS INFORMATION DOES NOT CONSTITUTE A WARRANTY WITH RESPECT TO THE PRODUCTS DESCRIBED HEREIN, AND QORVO HEREBY DISCLAIMS ANY AND ALL WARRANTIES WITH RESPECT TO SUCH PRODUCTS WHETHER EXPRESS OR IMPLIED BY LAW, COURSE OF DEALING, COURSE OF PERFORMANCE, USAGE OF TRADE OR OTHERWISE, INCLUDING THE IMPLIED WARRANTIES OF MERCHANTABILITY AND FITNESS FOR A PARTICULAR PURPOSE.**

Without limiting the generality of the foregoing, Qorvo products are not warranted or authorized for use as critical components in medical, life-saving, or life-sustaining applications, or other applications where a failure would reasonably be expected to cause severe personal injury or death.

Copyright 2023 © Qorvo, Inc. | Qorvo is a registered trademark of Qorvo, Inc.