

SERIES TL1105 SWITCHES

TACT SWITCHES - 6mm x 6mm

TACT SWITCHES

NAVIGATION SWITCHES

PUSHBUTTON SWITCHES

TOGGLE SWITCHES

ROCKER SWITCHES

SLIDE SWITCHES

SNAP-ACTION SWITCHES

DIP SWITCHES

KEYLOCK SWITCHES

ROTARY SWITCHES

DETECTOR SWITCHES

CAP OPTIONS



FEATURES & BENEFITS

- ▶ Reliable dome contact technology
- ▶ Strong tactile/audible feedback
- ▶ Multiple operating force options

APPLICATIONS/MARKETS

- ▶ Telecommunications
- ▶ Consumer Electronics
- ▶ Audio/visual
- ▶ Medical
- ▶ Testing/instrumentation
- ▶ Computer/servers/peripherals

SPECIFICATIONS

Contact Rating:	50mA @ 12 VDC (50mA @ 50VDC-gold)
Life Expectancy:	100,000 cycles
Contact Resistance:	100mΩ max., typical @ 2-4 VDC 100mA for both silver and gold plated contacts
Insulation Resistance:	100MΩ min.
Dielectric Strength:	250 VAC
Actuation Force:	100 ± 50 gf, 160 ± 50 gf, 250 ± 50 gf
Operating Temperature:	-20°C to 70°C
Travel:	0.25 Typ

MATERIALS

Housing:	Nylon or PBT
Actuator:	Nylon, Acetal or PBT
Cover:	Polyester
Contacts:	Gold or silver plated
Terminals:	Silver plated brass

HOW TO ORDER

SERIES	MODEL NO.	ACTUATOR ("L" Dimension)	OPERATING FORCE	CONTACT MTL./TERMINATION	CAP (Where Avail.)	CAP COLOR
TL TLE = Earth Ground	1105	(None) = 4.3mm A = 5.0mm B = 9.5mm C = 8.0mm D = 13.0mm E = 7.3mm F = 7.0mm G = 9.7mm H = 12.5mm K = 13.5mm L = 17.0mm P = 8.5mm Y = 16.3mm T = 2.4mm <input type="checkbox"/> SP = 2.8mm <input type="checkbox"/>	F100 F160 F250	Q = Silver R = Gold	See Cap Options Caps available for SP option only.	

- Square Snap-on Actuator Head "L" Dimension is 7.5mm

TL	1105 (Rt. Angle)	V = 3.85mm W = 3.15mm X = 5.85mm R = 6.15mm M = 6.85mm S = 8.35mm N = 11.85mm Q = 15.85mm J = 2.4mm <input type="checkbox"/> JA = 2.8mm <input type="checkbox"/>	F100 F160 F250	Q = Silver R = Gold	See Cap Options Caps available for JA option only.	
----	---------------------	---	----------------------	------------------------	---	--

- Square Snap-on Actuator Head "L" Dimension is 6.35mm

Example Ordering Number
TL-1105-SP-F160-Q-1R RED

Specifications subject to change without notice 2.28.2018



TL 1105

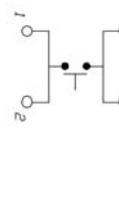

SCHEMATIC

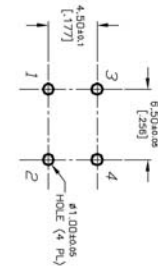

P.C. MOUNTING

TLE 1105

TLE (EARTH TERMINAL)

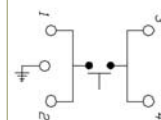
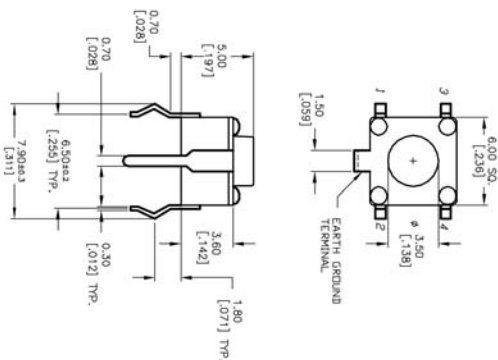

SCHEMATIC

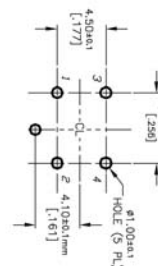

P.C. MOUNTING

TL 1105 T



Model No.	'S' Dim.
TL1105T	2.4 mm
TL1105SP	2.8 mm

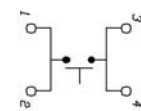
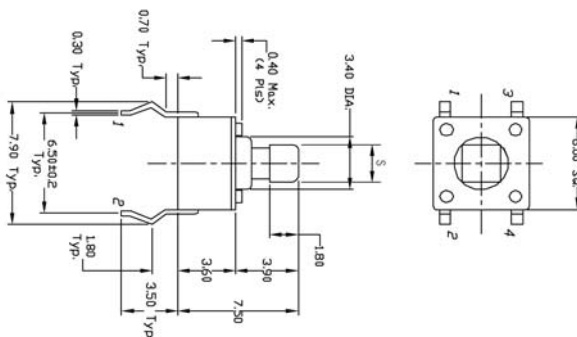

SCHEMATIC

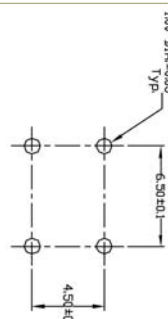

P.C. MOUNTING

TACT SWITCHES

NAVIGATION SWITCHES

PUSHBUTTON SWITCHES

TOGGLE SWITCHES

ROCKER SWITCHES

SLIDE SWITCHES

SNAP-ACTION SWITCHES

DIP SWITCHES

KEYLOCK SWITCHES

ROTARY SWITCHES

DETECTOR SWITCHES

CAP OPTIONS

SERIES TL1105 SWITCHES

TACT SWITCHES - 6mm x 6mm

TACT SWITCHES

TL 1105 J

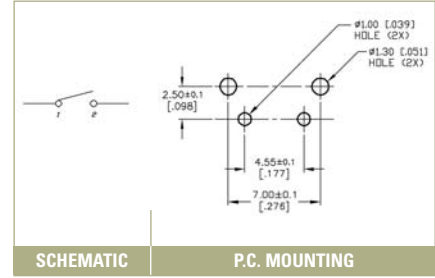
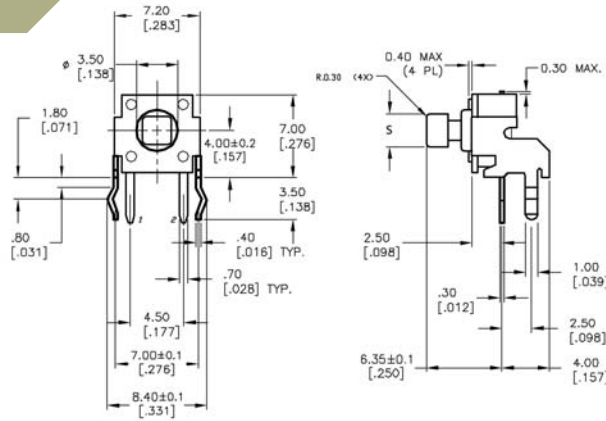

SCHEMATIC

P.C. MOUNTING

Model No.	'S' Dim.
TL1105J	2.4 mm
TL1105JA	2.8 mm

NAVIGATION SWITCHES

PUSHBUTTON SWITCHES

TOGGLE SWITCHES

ROCKER SWITCHES

TL 1105

RIGHT ANGLE

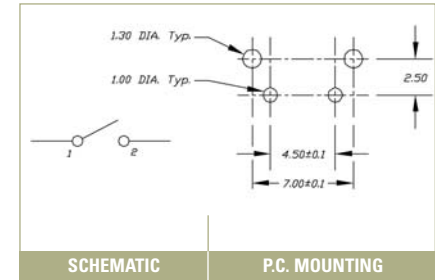
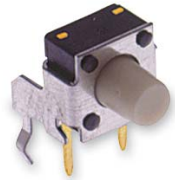

SCHEMATIC

P.C. MOUNTING

SLIDE SWITCHES

SNAP-ACTION SWITCHES

DIP SWITCHES

KEYLOCK SWITCHES

ROTARY SWITCHES

DETECTOR SWITCHES

CAP OPTIONS