

## 40V 1.5A Synchronous Step-Down COT Regulator

### Description

The **XR76201** is a synchronous step-down regulator combining the controller, drivers, bootstrap diode and MOSFETs in a single package for point-of-load supplies. The XR76201 is capable of supplying steady state loads of 1.5A. A wide 5V to 40V input voltage range allows for single supply operation from 12V battery systems required to withstand load dump, industry standard 24V  $\pm$ 10%, 18V to 36V, and rectified 18VAC and 24VAC rails.

With a proprietary emulated current mode Constant On-Time (COT) control scheme, the XR76201 provides extremely fast line and load transient response using ceramic output capacitors. They require no loop compensation, simplifying circuit implementation and reducing overall component count. The control loop also provides 0.05% load and 0.15% line regulation and maintains constant operating frequency. A selectable power saving mode allows the user to operate in Discontinuous Conduction Mode (DCM) at light current loads, thereby significantly increasing the converter efficiency.

A host of protection features, including overcurrent, over temperature, short-circuit and UVLO, helps achieve safe operation under abnormal operating conditions.

The XR76201 is available in a RoHS-compliant, green / halogen-free, space-saving 5mm x 5mm QFN package.

### FEATURES

- Controller, drivers, bootstrap diode and MOSFETs integrated in one package
- 1.5A step-down regulator
  - Wide 5V to 40V input voltage range
  - >0.6V adjustable output voltage
- Proprietary constant on-time control
  - No loop compensation required
  - Stable ceramic output capacitor operation
  - Programmable 100ns to 1 $\mu$ s on-time
  - Constant 400kHz to 800kHz frequency
- Selectable CCM or CCM / DCM
  - CCM / DCM for high efficiency at light-load
  - CCM for constant frequency at light-load
- Programmable hiccup current limit with thermal compensation
- Precision enable and Power Good flag
- Programmable soft-start
- 30-pin 5mm x 5mm QFN package

### APPLICATIONS

- Automotive systems
- Industrial
- Military

Ordering Information – [back page](#)

### Typical Application

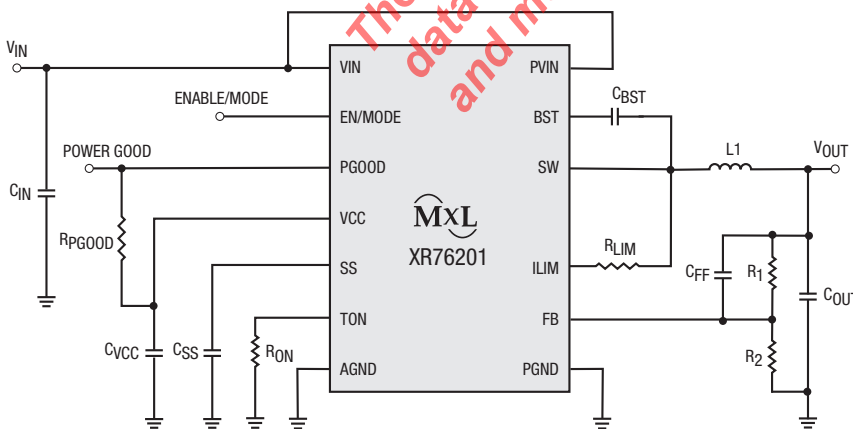

Figure 1. Typical Application

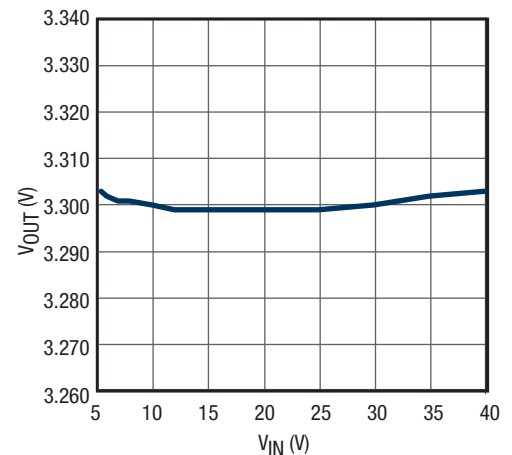

Figure 2. Line Regulation

## Absolute Maximum Ratings

Stresses beyond the limits listed below may cause permanent damage to the device. Exposure to any Absolute Maximum Rating condition for extended periods may affect device reliability and lifetime.

$PV_{IN}, V_{IN}$	-0.3V to 43V
$V_{CC}$	-0.3V to 6.0V
BST	-0.3V to 48V <sup>(1)</sup>
BST-SW	-0.3V to 6V
SW, ILIM	-1V to 43V <sup>(1)(2)</sup>
ALL other pins	-0.3V to $V_{CC} + 0.3V$
Storage temperature	-65°C to 150°C
Junction temperature	150°C
Power dissipation	Internally limited
Lead temperature (soldering, 10 sec)	300°C
ESD rating (HBM - Human Body Model)	2kV

### NOTES:

1. No external voltage applied.
2. SW pin's minimum DC range is -1V, transient is -5V for less than 50ns.
3. Recommended frequency for optimum performance.

## Operating Conditions

$PV_{IN}$	5V to 40V
$V_{IN}$	5V to 40V
SW, ILIM	-1V to 40V <sup>(1)</sup>
PGOOD, VCC, TON, SS, EN, FB	-0.3V to 5.5V
Switching frequency	400kHz to 800kHz <sup>(3)</sup>
Junction temperature range	-40°C to 125°C
JEDEC51 package thermal resistance, $\theta_{JA}$	28°C/W
Package power dissipation at 25°C	3.6W

## Electrical Characteristics

Unless otherwise noted:  $T_J = 25^\circ\text{C}$ ,  $V_{IN} = 24\text{V}$ ,  $BST = V_{CC}$ ,  $SW = AGND = PGND = 0\text{V}$ ,  $C_{VCC} = 4.7\mu\text{F}$ . Limits applying over the full operating temperature range are denoted by a •.

Symbol	Parameter	Conditions	•	Min	Typ	Max	Units
<b>Power Supply Characteristics</b>							
$V_{IN}$	Input voltage range	$V_{CC}$ regulating	•	5.5		40	V
$I_{VIN}$	$V_{IN}$ input supply current	Not switching, $V_{IN} = 24\text{V}$ , $V_{FB} = 0.7\text{V}$	•		0.7	2	mA
$I_{VIN}$	$V_{IN}$ input supply current	$f = 300\text{kHz}$ , $R_{ON} = 215\text{k}\Omega$ , $V_{FB} = 0.58\text{V}$			12		mA
$I_{OFF}$	Shutdown current	Enable = 0V, $V_{IN} = 12\text{V}$			1		$\mu\text{A}$
<b>Enable and Under-Voltage Lock-Out UVLO</b>							
$V_{IH\_EN\_1}$	EN pin rising threshold		•	1.8	1.9	2.0	V
$V_{EN\_H\_1}$	EN pin hysteresis				70		mV
$V_{IH\_EN\_2}$	EN pin rising threshold for DCM/CCM operation		•	2.8	3.0	3.1	V
$V_{EN\_H\_2}$	EN pin hysteresis				100		mV
	$V_{CC}$ UVLO start threshold, rising edge		•	4.00	4.25	4.40	V
	$V_{CC}$ UVLO hysteresis				230		mV

## Electrical Characteristics (Continued)

Unless otherwise noted:  $T_J = 25^\circ\text{C}$ ,  $V_{IN} = 24\text{V}$ ,  $BST = V_{CC}$ ,  $SW = AGND = PGND = 0\text{V}$ ,  $C_{VCC} = 4.7\mu\text{F}$ . Limits applying over the full operating temperature range are denoted by a •.

Symbol	Parameter	Conditions	•	Min	Typ	Max	Units
Reference Voltage							
$V_{REF}$	Reference voltage	$V_{IN} = 5.5\text{V to } 40\text{V}$ , $V_{CC}$ regulating	•	0.596	0.600	0.604	V
			•	0.594	0.600	0.606	V
	DC line regulation	CCM, closed loop, $V_{IN} = 5.5\text{V to } 40\text{V}$ , applies to any $C_{OUT}$			$\pm 0.15$		%
	DC load regulation	CCM, closed loop, applies to any $C_{OUT}$			$\pm 0.05$		%
Programmable Constant On-Time							
$t_{ON1}$	On-time 1	$R_{ON} = 6.04\text{k}\Omega$ , $V_{IN} = 24\text{V}$	•	85	100	117	ns
	f corresponding to on-time 1	$V_{OUT} = 1.8\text{V}$ , $V_{IN} = 24\text{V}$ , $R_{ON} = 6.04\text{k}\Omega$ , $I_{OUT} = 1.5\text{A}$	•	710	830	980	kHz
$t_{ON(MIN)}$	Minimum programmable on-time	$R_{ON} = 6.04\text{k}\Omega$ , $V_{IN} = 24\text{V}$		85	100	117	ns
$t_{ON2}$	On-time 2	$R_{ON} = 14\text{k}\Omega$ , $V_{IN} = 24\text{V}$	•	174	205	236	ns
$t_{ON3}$	On-time 3	$R_{ON} = 35.7\text{k}\Omega$ , $V_{IN} = 24\text{V}$	•	407	479	550	ns
	f corresponding to on-time 2	$V_{OUT} = 1.8\text{V}$ , $V_{IN} = 24\text{V}$ , $R_{ON} = 14\text{k}\Omega$ , $I_{OUT} = 1.5\text{A}$	•	345	400	470	kHz
	Minimum off-time		•		250	350	ns
Diode Emulation Mode							
	Zero crossing threshold	DC value measured during test			-2		mV
Soft-Start							
	SS charge current		•	-14	-10	-6	$\mu\text{A}$
	SS discharge current	Fault present	•	1			mA
$V_{CC}$ Linear Regulator							
	$V_{CC}$ output voltage	$V_{IN} = 6\text{V to } 40\text{V}$ , $I_{LOAD} = 0$ to $30\text{mA}$	•	4.8	5.0	5.2	V
		$V_{IN} = 5\text{V}$ , $I_{LOAD} = 0$ to $20\text{mA}$	•	4.51	4.7		V
Power Good Output							
	Power good threshold			-10	-6.9	-5	%
	Power good hysteresis				1.6	4	%
	Power good sink current			1			mA

## Electrical Characteristics (Continued)

Unless otherwise noted:  $T_J = 25^\circ\text{C}$ ,  $V_{IN} = 24\text{V}$ ,  $BST = V_{CC}$ ,  $SW = AGND = PGND = 0\text{V}$ ,  $C_{VCC} = 4.7\mu\text{F}$ . Limits applying over the full operating temperature range are denoted by a •.

Symbol	Parameter	Conditions	•	Min	Typ	Max	Units
Protection: OCP, OTP, Short-Circuit							
	Hiccup timeout				110		ms
	$I_{LIM}$ pin source current			45	50	55	$\mu\text{A}$
	$I_{LIM}$ current temperature coefficient				0.4		$\%/^\circ\text{C}$
	OCP comparator offset		•	-8	0	8	mV
	Current limit blanking	GL rising > 1V			100		ns
	Thermal shutdown threshold <sup>(1)</sup>	Rising temperature			150		$^\circ\text{C}$
	Thermal hysteresis <sup>(1)</sup>				15		$^\circ\text{C}$
	VSCTH feedback pin short-circuit threshold	Percent of $V_{REF}$ , short-circuit is active after PGOOD is asserted	•	50	60	70	%
Output Power Stage							
$R_{DS(on)}$	High-side MOSFET $R_{DS(on)}$	$I_{DS} = 1\text{A}$			115	160	$\text{m}\Omega$
	Low-side MOSFET $R_{DS(on)}$				40	59	$\text{m}\Omega$
$I_{OUT}$	Maximum output current		•	1.5A			A
	Maximum ambient temperature at continuous load	$V_{IN} = 24\text{V}$ , $V_{OUT} = 5\text{V}$ , $I_{OUT} = 1.5\text{A}$ , $f = 700\text{kHz}$				100	$^\circ\text{C}$
		$V_{IN} = 12\text{V}$ , $V_{OUT} = 5\text{V}$ , $I_{OUT} = 1.5\text{A}$ , $f = 600\text{kHz}$				110	$^\circ\text{C}$

### NOTE:

1. Guaranteed by design.

The product (or products) mentioned in this data sheet are no longer being manufactured and may not be ordered (OBS)

## Pin Configuration, Top View

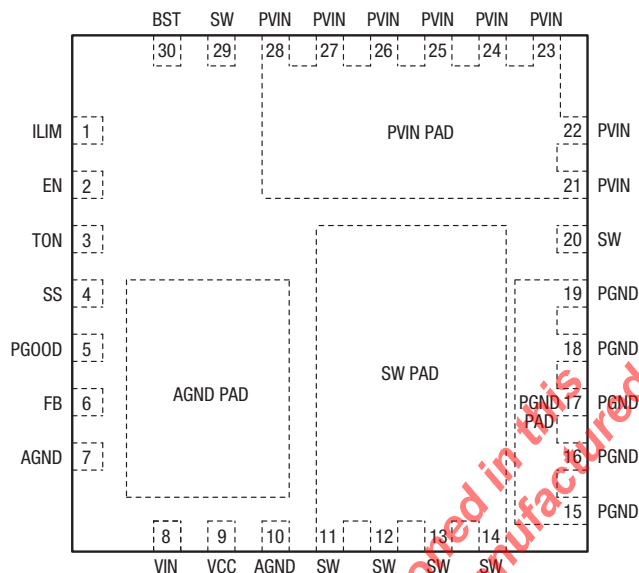

## Pin Functions

Pin Number	Pin Name	Type	Description
1	ILIM	A	Overcurrent protection programming. Connect with a resistor to SW.
2	EN/MODE	I	Precision enable pin. Pulling this pin above 1.9V will turn the regulator on and it will operate in CCM. If the voltage is raised above 3.0V, then the regulator will operate in DCM / CCM depending on load.
3	TON	A	Constant on-time programming pin. Connect with a resistor to AGND.
4	SS	A	Soft-start pin. Connect an external capacitor between SS and AGND to program the soft-start rate based on the 10 $\mu$ A internal source current.
5	PGOOD	O, OD	Power-good output. This open-drain output is pulled low when V <sub>OUT</sub> is outside the regulation.
6	FB	A	Feedback input to feedback comparator. Connect with a set of resistors to V <sub>OUT</sub> and AGND in order to program V <sub>OUT</sub> .
7, 10, AGND Pad	AGND	A	Signal ground for control circuitry. Connect AGND Pad with a short trace to pins 7 and 10.
8	VIN	A	Supply input for the regulator's LDO. Normally it is connected to PVIN.
9	VCC	A	The output of regulator's LDO. For operation using a 5V rail, VCC should be shorted to VIN.
11-14, 20, 29, SW Pad	SW	PWR	Switch node. The drain of the low-side N-channel MOSFET. The source of the high-side MOSFET is wire-bonded to the SW Pad. Pins 20 and 29 are internally connected to SW pad.
15-19, PGND Pad	PGND	PWR	Ground of the power stage. Should be connected to the system's power ground plane. The source of the low-side MOSFET is wire-bonded to PGND Pad.
21-28, PVIN Pad	PVIN	PWR	Input voltage for power stage. The drain of the high-side N-channel MOSFET.
30	BST	A	High-side driver supply pin. Connect a bootstrap capacitor between BST and pin 29.

### NOTE:

A = Analog, I = Input, O = Output, OD = Open Drain, PWR = Power.

### Typical Performance Characteristics

Unless otherwise noted:  $V_{IN} = 24V$ ,  $V_{OUT} = 3.3V$ ,  $I_{OUT} = 1.5A$ ,  $f = 600kHz$ ,  $T_A = 25^\circ C$ . The application circuit is from the Application Information section.

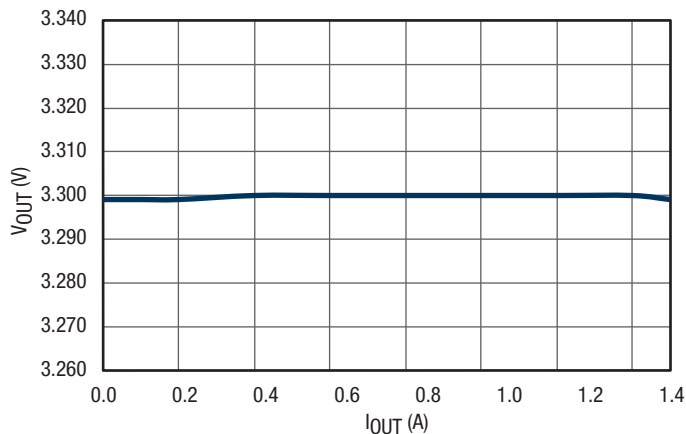

Figure 3.  
Load Regulation

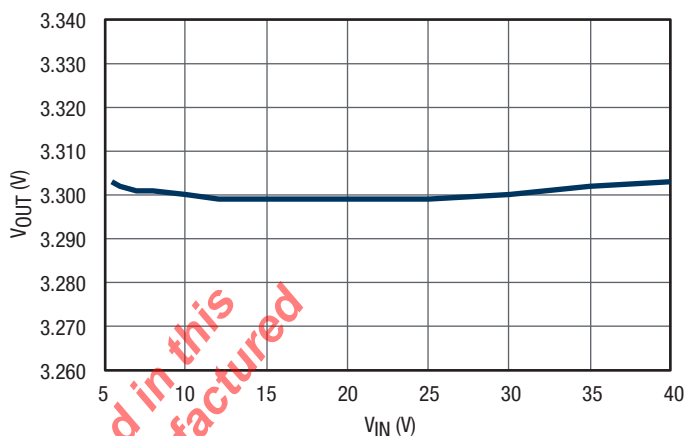

Figure 4.  
Line Regulation

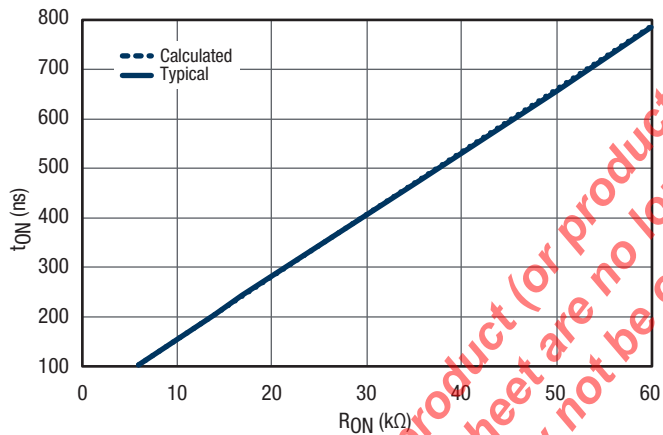

Figure 5.  
 $t_{ON}$  vs.  $R_{ON}$

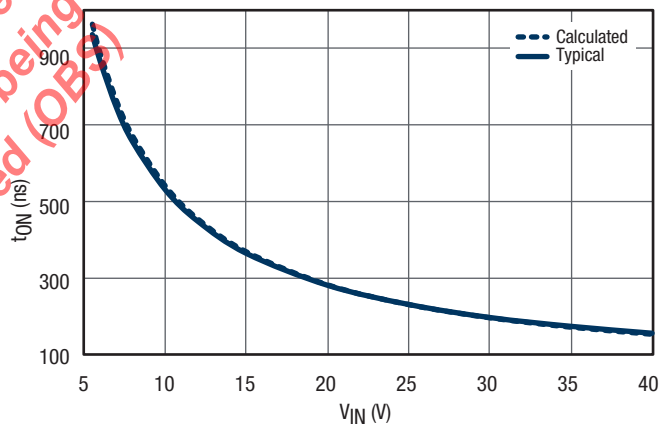

Figure 6.  
 $t_{ON}$  vs.  $V_{IN}$ ,  $R_{ON} = 16.9k\Omega$

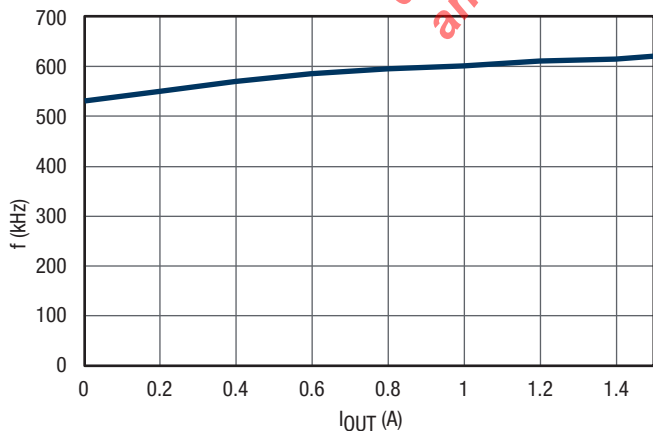

Figure 7.  
Frequency vs.  $I_{OUT}$

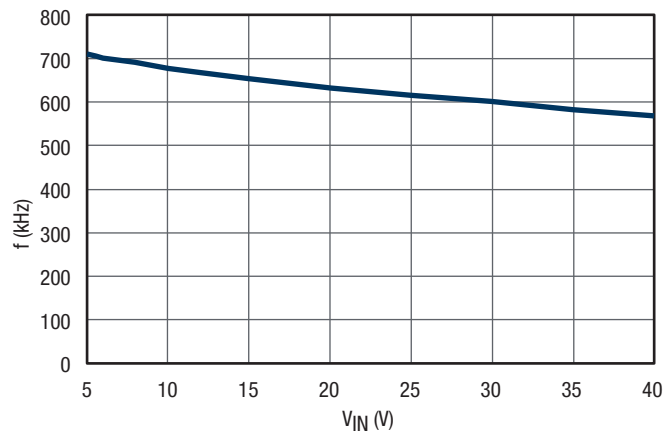

Figure 8.  
Frequency vs.  $V_{IN}$

## Typical Performance Characteristics (Continued)

Unless otherwise noted:  $V_{IN} = 24V$ ,  $V_{OUT} = 3.3V$ ,  $I_{OUT} = 1.5A$ ,  $f = 600kHz$ ,  $T_A = 25^\circ C$ . The application circuit is from the Application Information section.

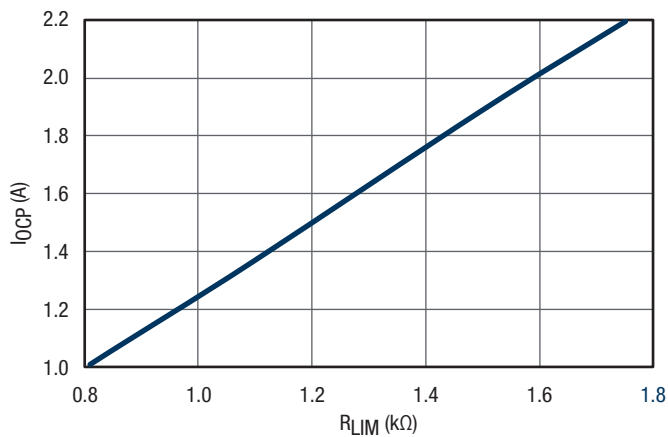

Figure 9.  
 $I_{OCP}$  vs.  $R_{LIM}$

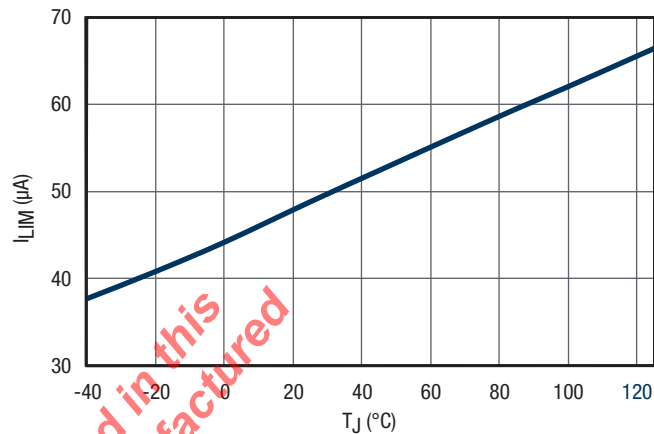

Figure 10.  
 $I_{LIM}$  vs. Temperature

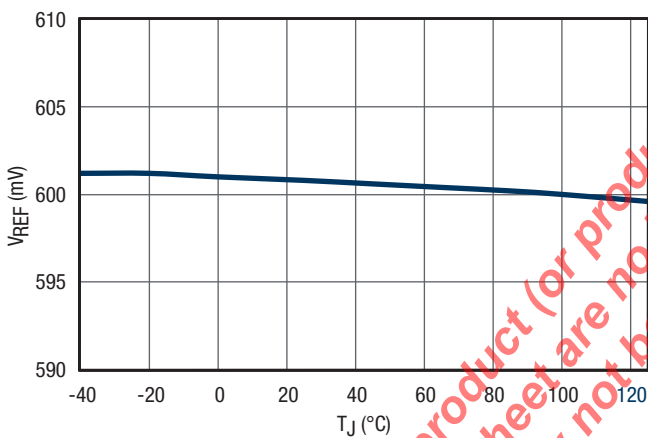

Figure 11.  
 $V_{REF}$  vs. Temperature

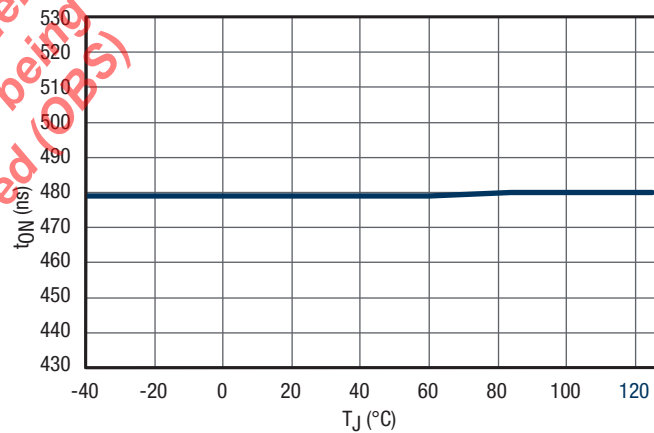

Figure 12.  
 $t_{ON}$  vs. Temperature,  $R_{ON} = 35.7k\Omega$

Typical Performance Characteristics (Continued)

Unless otherwise noted:  $V_{IN} = 24V$ ,  $V_{OUT} = 3.3V$ ,  $I_{OUT} = 1.5A$ ,  $f = 600kHz$ ,  $T_A = 25^\circ C$ . The application circuit is from the Application Information section.

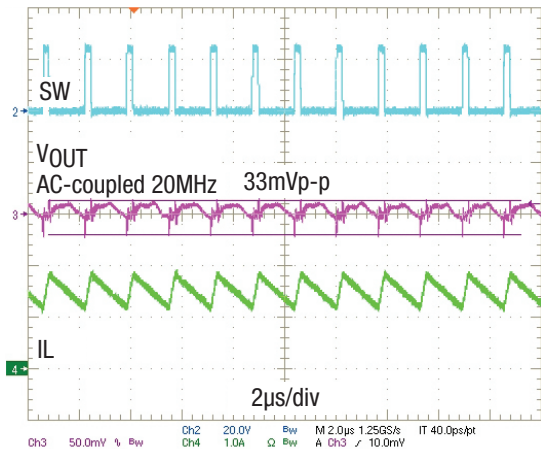

Figure 13.  
Steady State,  $I_{OUT} = 1.5A$

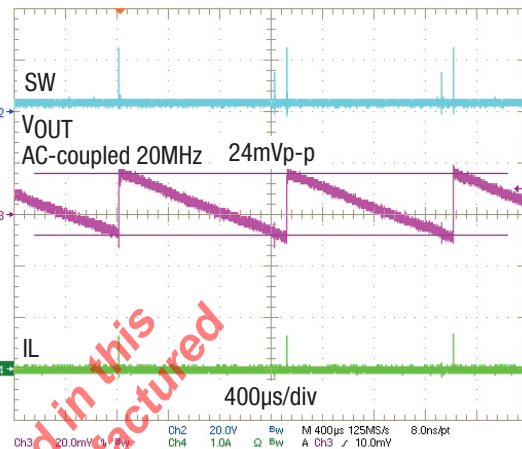

Figure 14.  
Steady State, DCM,  $I_{OUT} = 0A$

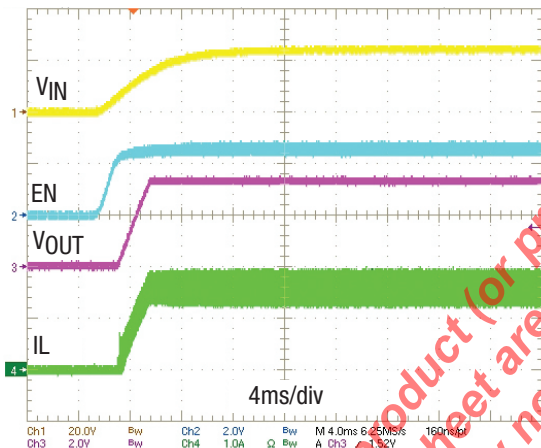

Figure 15.  
Power Up, Forced CCM

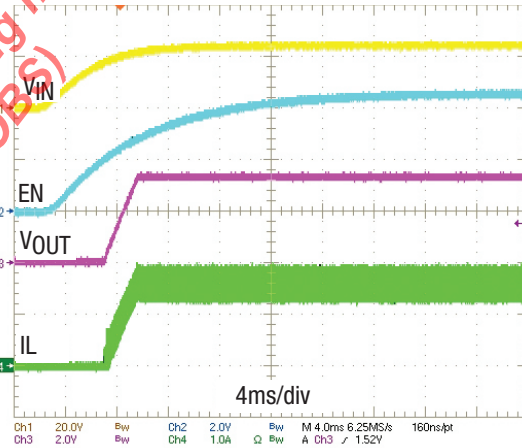

Figure 16.  
Power Up, DCM / CCM

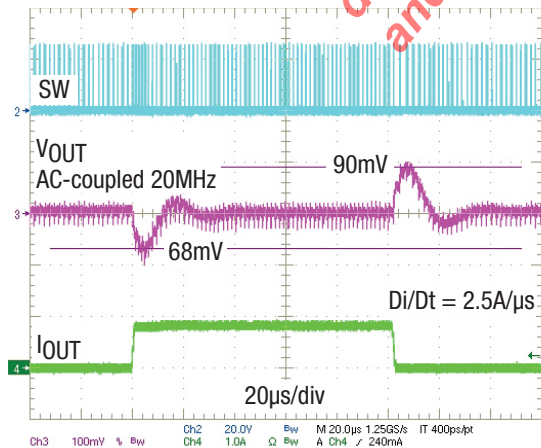

Figure 17.  
Load Step, Forced CCM, 0A - 0.8A

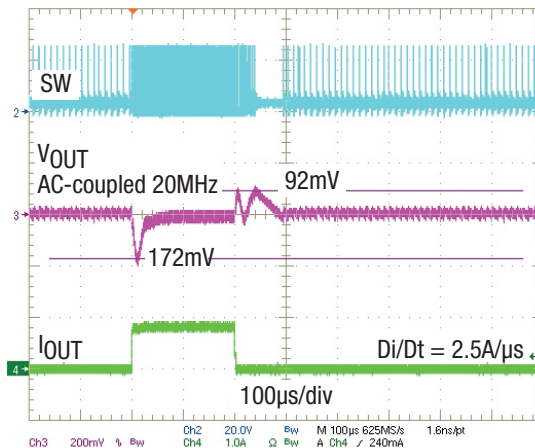

Figure 18.  
Load Step, DCM / CCM, 0.05A - 0.85A



Typical Performance Characteristics (Continued)

Efficiency

Unless otherwise noted:  $T_{AMBIENT} = 25^{\circ}C$ , no air flow,  $L = 6.8\mu H$ , inductor losses are included, application circuit is from the Application Information section.

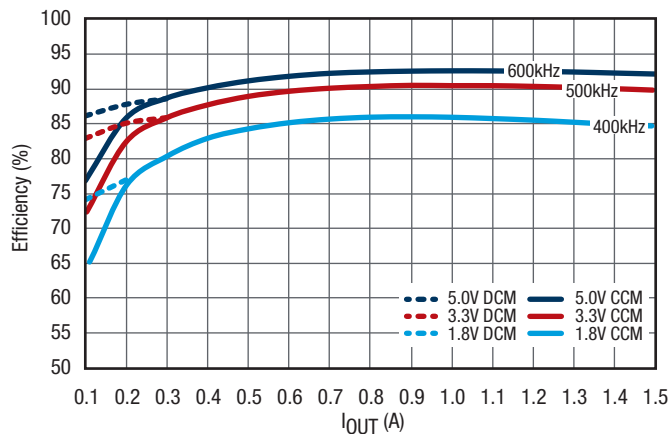

Figure 19.  
Efficiency,  $V_{IN} = 12V$

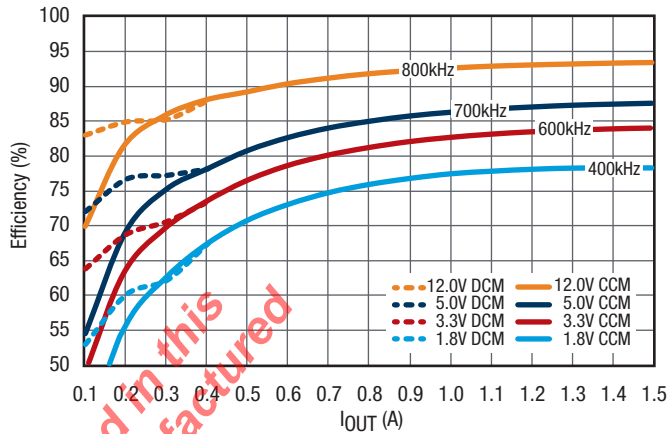

Figure 20.  
Efficiency,  $V_{IN} = 24V$

The product (or products) mentioned in this data sheet are no longer being manufactured and may not be ordered (OBS)

Functional Block Diagram

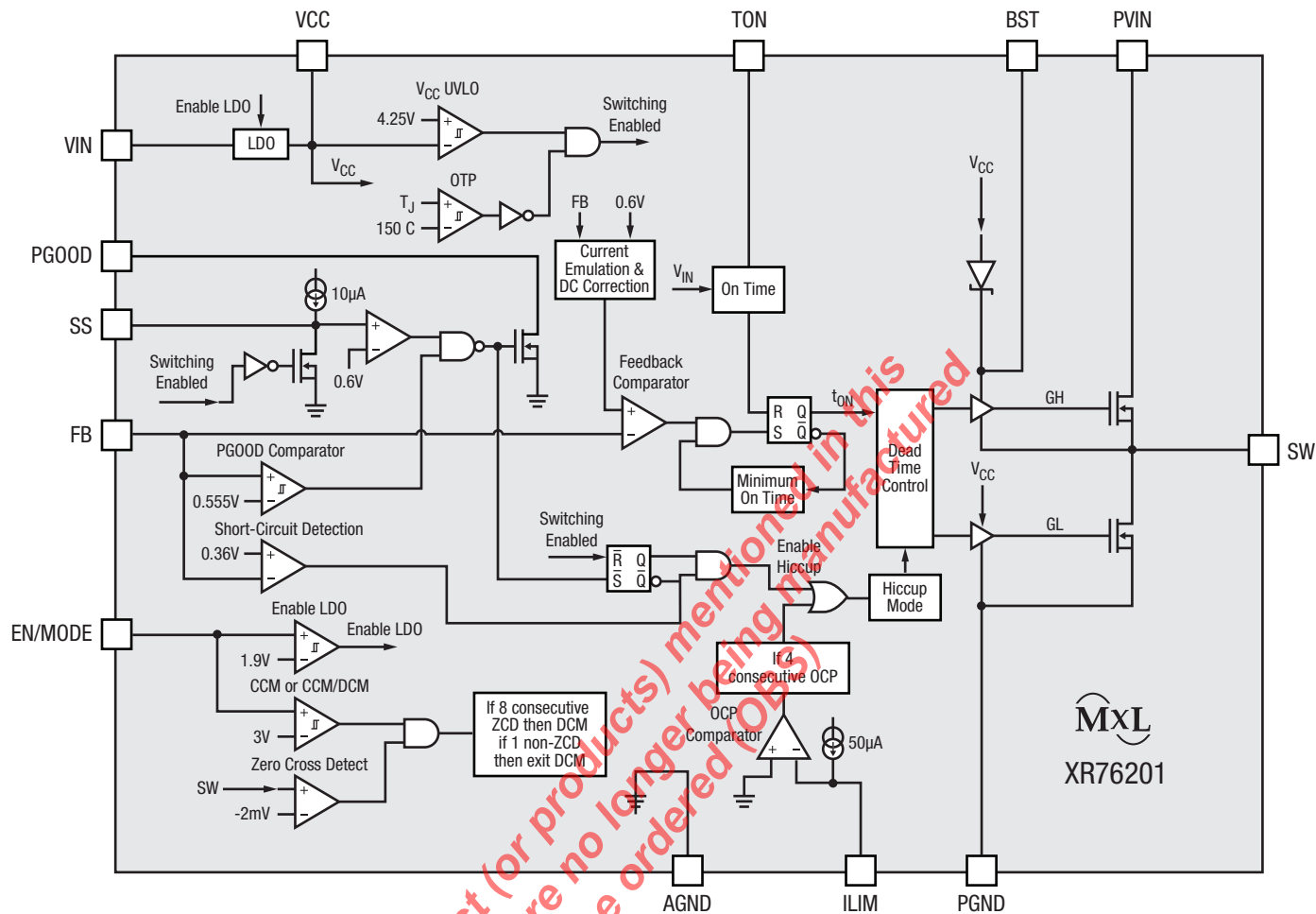

Figure 21. Functional Block Diagram

The product (or products) mentioned in this data sheet are no longer being manufactured and may not be ordered (DPS)

## Applications Information

### Functional Description

XR76201 is a synchronous step-down, proprietary emulated current-mode Constant On-Time (COT) regulator. The on-time, which is programmed via  $R_{ON}$ , is inversely proportional to  $V_{IN}$  and maintains a nearly constant frequency. The emulated current-mode control is stable with ceramic output capacitors.

Each switching cycle begins with GH signal turning on the high-side (control) FET for a preprogrammed time. At the end of the on-time, the high-side FET is turned off and the low-side (synchronous) FET is turned on for a preset minimum time (250ns nominal). This parameter is termed Minimum Off-Time. After the Minimum Off-Time, the voltage at the feedback pin FB is compared to an internal voltage ramp at the feedback comparator. When  $V_{FB}$  drops below the ramp voltage, the high-side FET is turned on and the cycle repeats. This voltage ramp constitutes an emulated current ramp and makes possible the use of ceramic capacitors, in addition to other capacitor types, for output filtering.

### Enable/Mode Input (EN/MODE)

EN/MODE pin accepts a tri-level signal that is used to control turn on / off. It also selects between two modes of operation: 'Forced CCM' and 'DCM / CCM'. If EN/MODE is pulled below 1.8V, the regulator shuts down. A voltage between 2.0V and 2.8V selects the Forced CCM mode, which will run the regulator in continuous conduction at all times. A voltage higher than 3.1V selects the DCM / CCM mode, which will run the regulator in discontinuous conduction at light loads.

### Selecting the Forced CCM Mode

In order to set the regulator to operate in Forced CCM, a voltage between 2.0V and 2.8V must be applied to EN/MODE. This can be achieved with an external control signal that meets the above voltage requirement. Where an external control is not available, the EN/MODE can be derived from  $V_{IN}$ . If  $V_{IN}$  is well regulated, use a resistor divider and set the voltage to 2.5V. If  $V_{IN}$  varies over a wide range, the circuit shown in Figure 22 can be used to generate the required voltage. Note that at  $V_{IN}$  of 5.5V and 40V, the nominal Zener voltage is 4.0V and 5.0V respectively. Therefore for  $V_{IN}$  in the range of 5.5V to 40V, the circuit shown in Figure 22 will generate the  $V_{EN}$  required for Forced CCM.

### Selecting the DCM / CCM Mode

In order to set the regulator operation to DCM / CCM, a voltage between 3.1V and 5.5V must be applied to the EN/MODE pin. If an external control signal is available, it can be directly connected to EN/MODE. In applications where an external control is not available, the EN/MODE input can be derived from  $V_{IN}$ . If  $V_{IN}$  is well regulated, use a resistor divider and set the voltage to 4V. If  $V_{IN}$  varies over a wide range, the circuit shown in Figure 23 can be used to generate the required voltage.

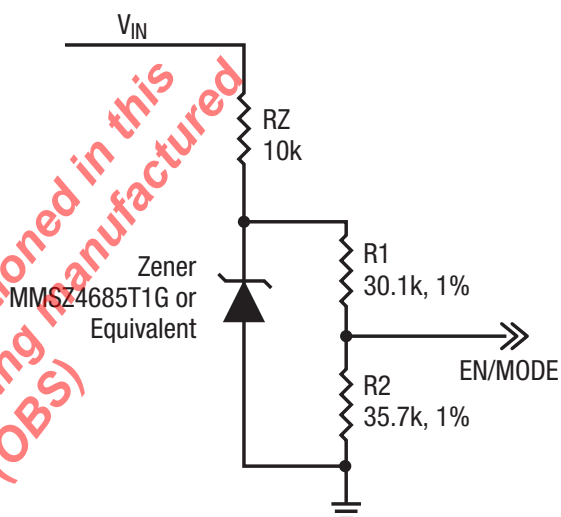

Figure 22.  
Selecting Forced CCM by Deriving EN/MODE from  $V_{IN}$

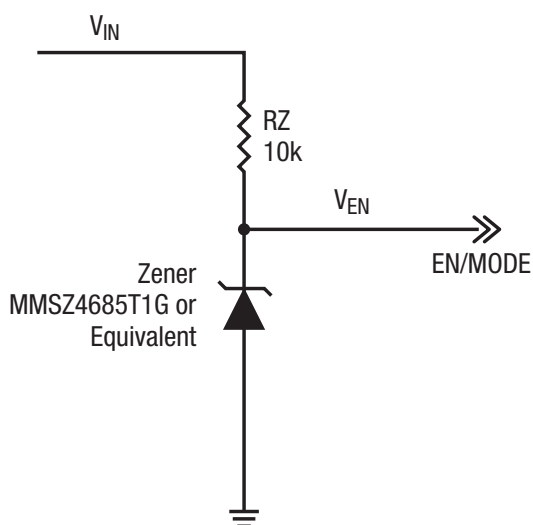

Figure 23.  
Selecting DCM/CCM by Deriving EN/MODE from  $V_{IN}$

## Applications Information (Continued)

### Programming the On-Time

The on-time  $t_{ON}$  is programmed via resistor  $R_{ON}$  according to following equation:

$$R_{ON} = \frac{V_{IN} \times [t_{ON} - (2.5 \times 10^{-8})]}{3.05 \times 10^{-10}}$$

A graph of  $t_{ON}$  vs.  $R_{ON}$ , using the above equation, is compared to typical test data in Figure 5. The graph shows that calculated data matches typical test data within 3%.

The  $t_{ON}$  corresponding to a particular set of operating conditions can be calculated based on empirical data from:

$$t_{ON} = \frac{V_{OUT}}{V_{IN} \times 0.97 \times f}$$

Where:

- $f$  is the desired switching frequency at 1.5A

Substituting for  $t_{ON}$  in the first equation we get:

$$R_{ON} = \frac{\left( \frac{V_{OUT}}{0.97 \times f} \right) - [(2.5 \times 10^{-8}) \times V_{IN}]}{(3.05 \times 10^{-10})}$$

Now  $R_{ON}$  can be calculated in terms of operating conditions  $V_{IN}$ ,  $V_{OUT}$ , and  $f$  using the above equation.

At  $V_{IN} = 24V$ ,  $I_{OUT} = 1.5A$  we get the following  $R_{ON}$ :

$V_{OUT}$ (V)	$f$ (kHz)	$R_{ON}$ (k $\Omega$ )
12	800	48.7
5	700	22.2
3.3	600	16.6
1.8	400	13.2

### Overcurrent Protection (OCP)

If load current exceeds the programmed overcurrent  $I_{OCP}$  for four consecutive switching cycles, the module enters the hiccup mode of operation. In hiccup, the MOSFET gates are turned off for 110ms (hiccup timeout). Following the hiccup timeout, a soft-start is attempted. If OCP persists, the hiccup timeout will repeat. The module will remain in hiccup mode until load current is reduced below the programmed  $I_{OCP}$ . In order to program the overcurrent protection, use the following equation:

$$R_{LIM} = \frac{(I_{OCP} \times 59m\Omega) + 8mV}{I_{LIM}}$$

where:

- $R_{LIM}$  is resistor value for programming  $I_{OCP}$
- $I_{OCP}$  is the overcurrent threshold to be programmed
- 8mV is the OCP comparator maximum offset
- $I_{LIM}$  is the internal current that generates the necessary OCP comparator threshold (use 45 $\mu$ A).

Note that  $I_{LIM}$  has a positive temperature coefficient of 0.4%/°C, Figure 10. This is meant to roughly match and compensate for positive temperature coefficient of the synchronous FET. The above equation is for worst-case analysis and safeguards against premature OCP. Typical value of  $I_{OCP}$ , for a given  $R_{LIM}$ , will be higher than that predicted by the above equation. A graph of calculated  $I_{OCP}$  vs.  $R_{LIM}$  is compared to typical  $I_{OCP}$  in Figure 9.

### Short-Circuit Protection (SCP)

If the output voltage drops below 60% of its programmed value, the module will enter hiccup mode. Hiccup will persist until short-circuit is removed. The SCP circuit becomes active after PGOOD asserts high.

### Over-Temperature (OTP)

OTP triggers at a nominal die temperature of 150°C. The gate of switching FET and synchronous FET are turned off. When die temperature cools down to 135°C, soft-start is initiated and operation resumes.

### Programming the Output Voltage

Use an external voltage divider as shown in the Application Circuit to program the output voltage  $V_{OUT}$ .

$$R_1 = R_2 \times \left( \frac{V_{OUT}}{0.6V} - 1 \right)$$

where:  $R_2$  has a nominal value of 2k $\Omega$

### Programming the Soft-Start

Place a capacitor  $C_{SS}$  between the SS and AGND pins to program the soft-start. In order to program a soft-start time of  $t_{SS}$ , calculate the required capacitance  $C_{SS}$  from the following equation:

$$C_{SS} = t_{SS} \times \frac{10\mu A}{0.6V}$$

## Applications Information (Continued)

### Feed-Forward Capacitor ( $C_{FF}$ )

A feed-forward capacitor ( $C_{FF}$ ) may be necessary depending on the Equivalent Series Resistance (ESR) of  $C_{OUT}$ . If only ceramic output capacitors are used for  $C_{OUT}$ , then a  $C_{FF}$  is necessary. Calculate  $C_{FF}$  from:

$$C_{FF} = \frac{1}{2 \times \pi \times R_1 \times 7 \times f_{LC}}$$

where:

- $R_1$  is the resistor that is parallel with  $C_{FF}$
- $f_{LC}$  is calculated by the equation below:

$$f_{LC} = \frac{1}{2 \times \pi \times \sqrt{L \times C_{OUT}}}$$

The  $f_{LC}$  frequency must be less than 11kHz when using ceramic  $C_{OUT}$ . If necessary, increase  $L$  and / or  $C_{OUT}$  in order to meet this constraint.

When using capacitors with higher ESR such as the PANASONIC TPE series, a  $C_{FF}$  is not required provided following conditions are met:

1. The frequency of output filter LC double-pole  $f_{LC}$  should be less than 11kHz
2. The frequency of ESR Zero  $f_{ZERO,ESR}$  should be at least five times larger than  $f_{LC}$

Note that if  $f_{ZERO,ESR}$  is less than  $5 \times f_{LC}$ , then it is recommended to set the  $f_{LC}$  at less than 2kHz.  $C_{FF}$  is still not required.

### Maximum Allowable Voltage Ripple at FB Pin

Note that the steady-state voltage ripple at feedback pin FB ( $V_{FB,RIPPLE}$ ) must not exceed 50mV in order for the regulator to function correctly. If  $V_{FB,RIPPLE}$  is larger than 50mV, then  $C_{OUT}$  should be increased as necessary in order to keep the  $V_{FB,RIPPLE}$  below 50mV.

### Feed-Forward Resistor ( $R_{FF}$ )

FET switching noise may couple to  $V_{OUT}$  through the parasitic capacitance across the inductor and to the FB pin via  $C_{FF}$ . Excessive noise at FB will cause poor load regulation. To solve this problem, place a resistor  $R_{FF}$  in series with  $C_{FF}$ . An  $R_{FF}$  value up to 2% of  $R_1$  is acceptable.

The product (or products) mentioned in this data sheet are no longer being manufactured and may not be ordered (OBS)

Applications Information (Continued)

Application Circuit

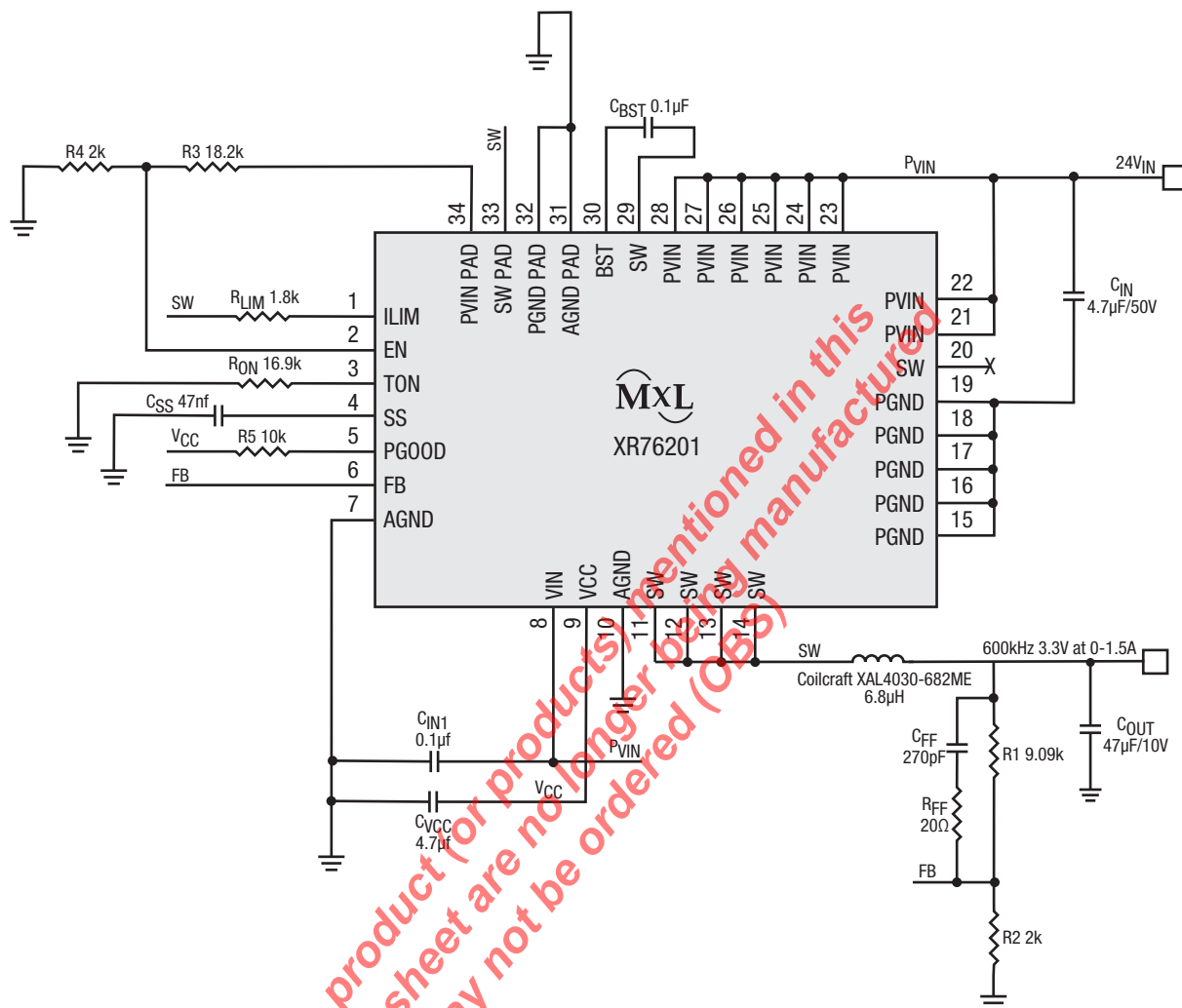

The product (or products) mentioned in this data sheet are no longer being manufactured and may not be ordered (OBSOLETE)

Figure 24. Application Circuit

Mechanical Dimensions

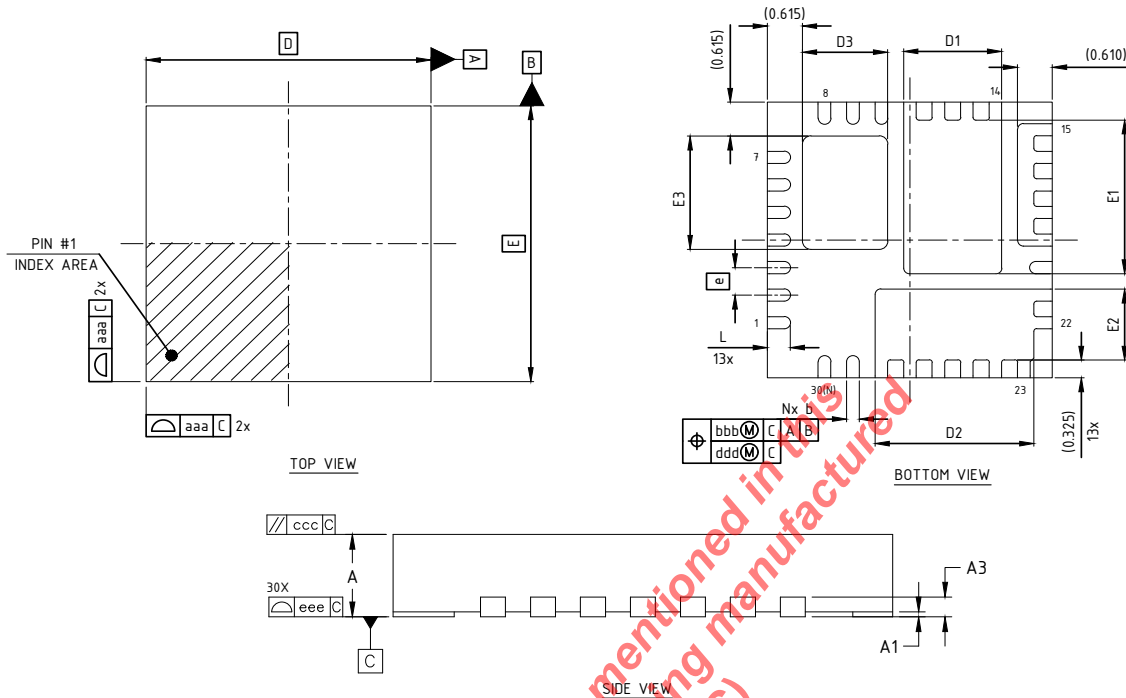

The product (or products) mentioned in this data sheet are no longer being manufactured (OBS) and may not be ordered.

Dimension Table			
Thickness Symbol	MINIMUM	NOMINAL	MAXIMUM
A	0.80	0.90	1.00
A1	0.00	0.02	0.05
A3	0.20 Ref.		
b	0.18	0.25	0.30
D	5.00 BSC		
E	5.00 BSC		
e	0.50 BSC		
D1	1.570	1.720	1.820
E1	2.635	2.785	2.885
D2	2.635	2.785	2.885
E2	1.135	1.285	1.385
D3	1.345	1.495	1.595
E3	1.903	2.053	2.153
L	0.30	0.40	0.50
aaa	0.05		
bbb	0.10		
ccc	0.10		
ddd	0.05		
eee	0.08		
N	30		

TERMINAL DETAIL

NOTE : ALL DIMENSIONS ARE IN MILLIMETERS, ANGLES ARE IN DEGREES.

Drawing No.: POD-00000018

Revision: B

Recommended Land Pattern and Stencil

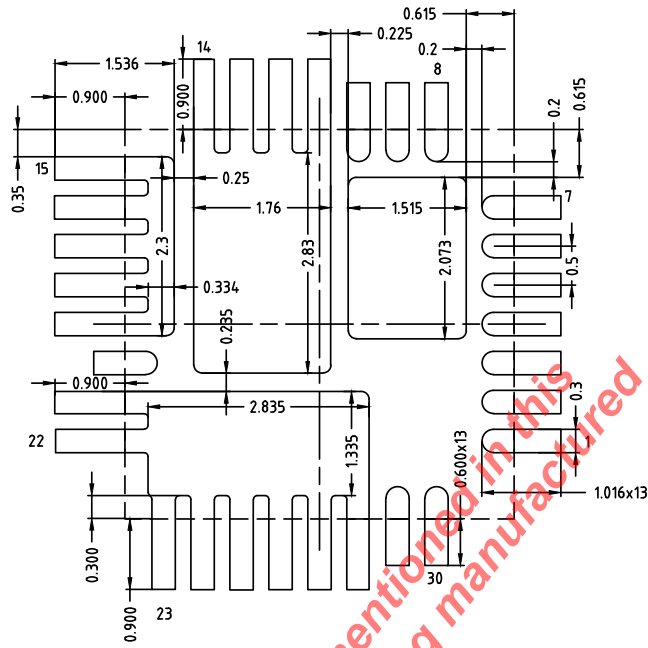

TYPICAL RECOMMENDED LAND PATTERN

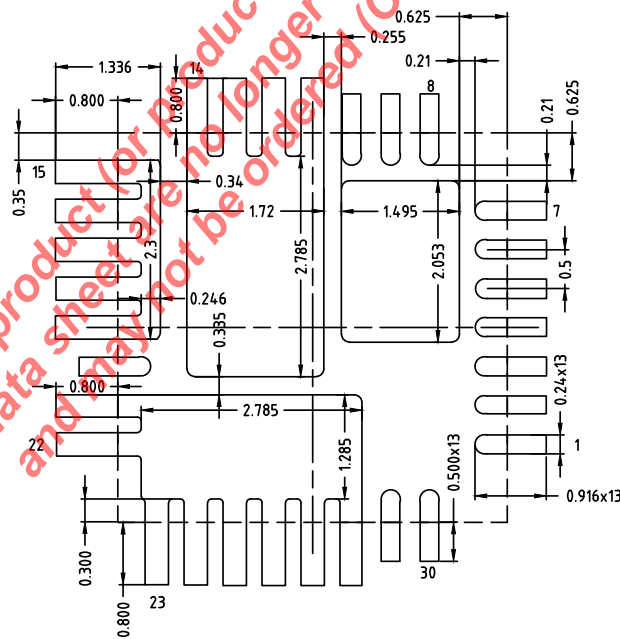

TYPICAL RECOMMENDED STENCIL

NOTE : ALL DIMENSIONS ARE IN MILLIMETERS, ANGLES ARE IN DEGREES.

Drawing No.: POD-00000018

Revision: B



Ordering Information<sup>(1)</sup>

Part Number	Operating Temperature Range	Package	Packaging Method	Lead-Free
XR76201ELTR	$-40^{\circ}\text{C} \leq T_J \leq 125^{\circ}\text{C}$	QFN 5x5	Tape and Reel	Yes <sup>(2)</sup>
XR76201EVB	XR76201 Evaluation Board			

**NOTE:**

1. Refer to [www.maxlinear.com/XR76201](http://www.maxlinear.com/XR76201) for most up-to-date Ordering Information.
2. Visit [www.maxlinear.com](http://www.maxlinear.com) for additional information on Environmental Rating.

## Revision History

Revision	Date	Description
1A	Sept 2016	Initial Release
1B	June 2018	Update to MaxLinear logo. Update format and Ordering Information.
1C	October 2019	Correct block diagram by changing the input gate into the Hiccup Mode from an AND gate to an OR gate. Update ordering information. Add recommended land pattern and stencil.

The product (or products) mentioned in this data sheet are no longer being manufactured and may not be ordered (OBS)



**Corporate Headquarters:**  
 5966 La Place Court  
 Suite 100  
 Carlsbad, CA 92008  
 Tel.: +1 (760) 692-0711  
 Fax: +1 (760) 444-8598  
[www.maxlinear.com](http://www.maxlinear.com)

The content of this document is furnished for informational use only, is subject to change without notice, and should not be construed as a commitment by MaxLinear, Inc. MaxLinear, Inc. assumes no responsibility or liability for any errors or inaccuracies that may appear in the informational content contained in this guide. Complying with all applicable copyright laws is the responsibility of the user. Without limiting the rights under copyright, no part of this document may be reproduced into, stored in, or introduced into a retrieval system, or transmitted in any form or by any means (electronic, mechanical, photocopying, recording, or otherwise), or for any purpose, without the express written permission of MaxLinear, Inc.

MaxLinear, Inc. does not recommend the use of any of its products in life support applications where the failure or malfunction of the product can reasonably be expected to cause failure of the life support system or to significantly affect its safety or effectiveness. Products are not authorized for use in such applications unless MaxLinear, Inc. receives, in writing, assurances to its satisfaction that: (a) the risk of injury or damage has been minimized; (b) the user assumes all such risks; (c) potential liability of MaxLinear, Inc. is adequately protected under the circumstances.

MaxLinear, Inc. may have patents, patent applications, trademarks, copyrights, or other intellectual property rights covering subject matter in this document. Except as expressly provided in any written license agreement from MaxLinear, Inc., the furnishing of this document does not give you any license to these patents, trademarks, copyrights, or other intellectual property.

MaxLinear, the MaxLinear logo, and any MaxLinear trademarks, MxL, Full-Spectrum Capture, FSC, G.now, AirPHY and the MaxLinear logo are all on the products sold, are all trademarks of MaxLinear, Inc. or one of MaxLinear's subsidiaries in the U.S.A. and other countries. All rights reserved. Other company trademarks and product names appearing herein are the property of their respective owners.

© 2016 - 2019 MaxLinear, Inc. All rights reserved